

# XCN<sup>®</sup> IMPLANT SYSTEM

---



## IMPLANTOLOGY

### PRODUCT CATALOGUE



**LEONE S.p.a.**

Orthodontics and Implantology

Via P. a Quaracchi, 50  
50019 Sesto Fiorentino  
Firenze ITALY  
Phone +39.0553044620  
Fax +39.055304405  
info@leone.it

[www.leone.it](http://www.leone.it)

8<sup>th</sup> English  
edition



## THE LEONE GROUP

Originated in 1934 from a small handicraft activity in Florence, the Leone company is today a high-tech industrial reality and a multinational company. In 2017 Leone experienced the acquisition of the US Distributor LeoneAmerica and the strengthening of sale activities through investments in the associate company Odontec in France. The manufacturing and industrial facilities are divided over an area of about 10.000 square meters where 150 working people operate. A new building of additional 2.000 square meters is located in front of the head quarter and was inaugurated in 2016, where brand-new equipment and machines compatible with the Industry 4.0 regulation are hosted; a short distance away, a new third building was founded in 2018 where the start-up Leone Digital Service is offering digital orthodontic solutions.



### RESEARCH

Most of the remarkable investments of the company are reserved to the Centre for Biotechnological Research "Marco Pozzi", which is located inside the company. Studies on materials, surfaces and technical analysis for new products are carried out here. The collaboration with either Italian or foreign Universities and the Faculties of Engineering and Medicine and Surgery in Florence is very close. Training stages and scientific research are developed for the preparation of graduation thesis.



### PRODUCTION

Engineers, mechanical and technical experts are making part of the manufacturing staff. Working side by side with the Centre for Biotechnological Research "Marco Pozzi" and making use of the most advanced technology, they are able to carry out the components of the two product ranges: orthodontics and implantology. All the innovations introduced in the production steps and the features of finished products are the result of consistent and in-depth studies as well as of remarkable investments.



### QUALITY PRODUCT CONTROL

The high quality of the Leone products is the result of sophisticated manufacturing techniques and accurate quality control conforming to UNI EN ISO 9001 and ISO 13485.



### TECHNICAL AND COMMERCIAL ASSISTANCE

Contact your dealer in your country as a reference.  
You will find the comprehensive list under the section "Distributors" in our website [www.leone.it](http://www.leone.it)



**LEONE S.p.a.**

Orthodontics and Implantology



#### **CUSTOMER SERVICE**

Leone is working non stop to satisfy the customer's expectations and is represented with dealers in 60 countries. A careful pre-sale and post-sale customer assistance is provided by qualified technical and commercial staff to meet any requirement.



#### **WAREHOUSE**

Finished and semi-finished products are stocked and organized by vertical lift automatic cabinets allowing a rationalization of the space and a fully computer based processing of the orders. Standard orders are shipped within 24 hours.



#### **EDUCATION TRAINING UPGRADE**

Equipped with every multimedia device, the facility of 1.000 sq.m is entirely dedicated to lectures and to the spreading of new therapeutic techniques. Training course, live demonstrations and cultural events are being held for either Italian or foreign specialists.

---

*In this catalogue you can find QR codes storing multimedia contents which can be downloaded directly on your smartphone. You can download free QR reader applications (e.g. [www.i-nigma.com](http://www.i-nigma.com)) except for the connecting charges. Videos are also available on our web-site: [www.leone.it/english/implantology](http://www.leone.it/english/implantology)*

---

#### **COMPETENCE AND RELIABILITY**

The Leone dealers worldwide are under constant professional improvement thanks to the technical assistance received by engineers and technical experts at Leone to get specific information on the products and solve any eventual problems from the customers.

# XCN<sup>®</sup> IMPLANT SYSTEM

## PRODUCT CATALOGUE



Alphabetical index	pages 156..157
XCN <sup>®</sup> Leone implants	pages 7..15
Accessories for surgical planning	page 16
Surgical instruments	pages 17..25
Surgical kits	pages 26..32
Products for soft tissue conditioning and prosthetic components	pages 33..41
Abutments for cement-retained prosthesis and impression accessories	pages 43..53
ExaConnect for screw-retained prosthesis and accessories	pages 55..62
Multi-Unit Abutments (MUA) for screw-retained prosthesis and accessories	pages 63..71
Conometric-retained prosthesis and accessories	pages 73..77
Abutments for attachment-retained prosthesis and accessories	pages 79..84
Prosthetic and laboratory instruments	pages 85..89
Demonstration and informative material	page 90



## SURGICAL PROCEDURE

pages 91..112

Disclaimer

and implant treatment planning

pages 92..94

Packaging and removal of  
XCN® implants

pages 95..97

Drilling protocol for

XCN® implants

pages 98..102

1) Preparation of the implant site

pages 103..104

2) Placement of the implant

pages 105..106

3) Healing options

page 107

3.1) Two-stage surgical procedure - first and second stage

pages 108..109

3.2) One-stage surgical procedure

page 110

3.3) Transgingival healing with ExaConnect Plus

page 111

3.4) Transgingival healing with MUA Plus

page 112

## PROSTHETIC PROCEDURE

pages 113..137

Disclaimer and premise

page 114

Conventional prosthetic workflows

Cement-retained single crown

page 115

Screw-retained single crown

pages 116..117

Cement-retained bridge

page 118

Screw-retained bridge/bar

page 119

All-on-four

page 120

Conometric-retained bridge

pages 121..122

Removable prosthesis on ball-head abutments

page 123

Removable conometric-retained prosthesis

page 124

Digital prosthetic workflows

Cement-retained single crown

pages 125..126

Cement-retained bridge/single crown

pages 127..128

Screw-retained single crown

pages 129..132

Screw-retained bridge/bar

pages 133..135

Conometric-retained bridge

pages 136..137

## LEONE MONOIMPLANTS FOR O-RING OVERDENTURE

pages 139..144

Surgical and prosthetic procedures

pages 145..154

Disclaimer and implant treatment planning

pages 146..147

Preparation of the implant site

pages 148..149

Packaging of the monoimplant

page 150

Insertion of the monoimplant

pages 151..152

Preparation of the removable prosthesis

pages 153..154



**XCN<sup>®</sup> IMPLANT SYSTEM**

---

IMPLANTS

## IMPLANT TYPES

The Leone implant system offers four different implant macro-designs:

- **Classix implant**  
featuring a cylindrical geometry;
- **Max Stability implant**  
having a root-form geometry and a more aggressive thread design;
- **2.9 Narrow implant**  
featuring a maximum diameter of only 2.9 mm;
- **6.5 Short implant**  
with a length reduced to 6.5 mm.

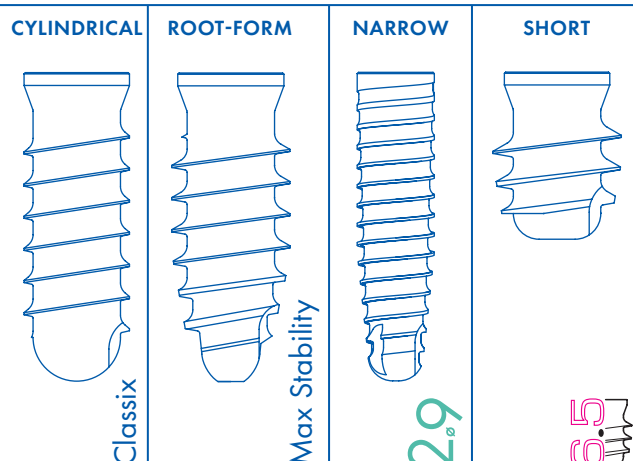

## IMPLANT-ABUTMENT MORSE TAPER CONNECTION

The distinctive feature of the system is the Leone implant-abutment connection, a combination of two geometries:

**screwless self-locking Morse taper\*** and internal hexagon.

The Morse taper and the absence of the abutment screw guarantee:

- no micro-movements;
- no micro-gaps, thus perfect bacterial seal;
- option of subcrestal placement of the implants;
- outstanding resistance to masticatory loads.

The result is a highly reliable system, very similar to the natural tooth.

*Bibliography: www.leone.it in the section "Scientific publications"*

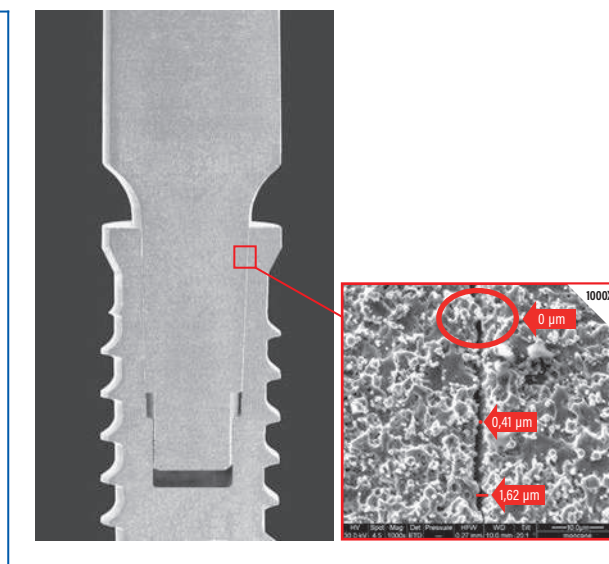

## PLATFORM SWITCHING

The "Platform Switching" design of the transmucosal portion increases the height and the volume of the soft tissue, thus sealing and protecting the underlying bone. In combination with the properties of the Morse taper connection, it promotes the maintenance of the periimplant tissues over time, as proven by long-term clinical studies.

*Bibliography: www.leone.it in the section "Scientific publications"*

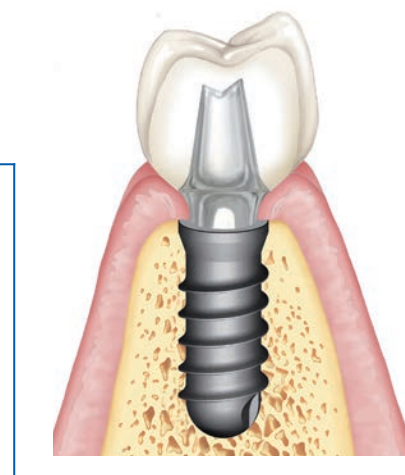

\*International UNI ISO 296

## HRS SURFACE

The HRS (High Rutile Surface) surface is obtained through an exclusive sandblasting process which produces an implant surface roughness  $R_a \approx 2.5 \mu\text{m}$  ( $R_a \approx 1 \mu\text{m}$  for 2.9 Narrow implants). The following cleaning treatments (passivation and decontamination) remove any organic and inorganic residues from the surface.

*Bibliography: www.leone.it in the section "Scientific publications"*

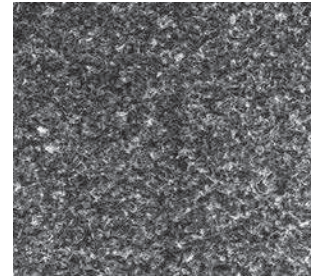

## IMPLANT PACKAGING

The sterile packaging includes a glass vial inside a blister, wrapped in a paper box.

The new box design ensures easy storage and identification of the product thanks to the large colour-coded label with detailed product information clearly visible when the boxes are stacked.

Each package includes multilingual instructions for use and four peel labels.



## COLOUR CODING OF IMPLANTS

Each implant is identified by a colour-coded carrier.

The innovative carrier is made of titanium core and a biopolymer outer shell in the colour code of the implant.

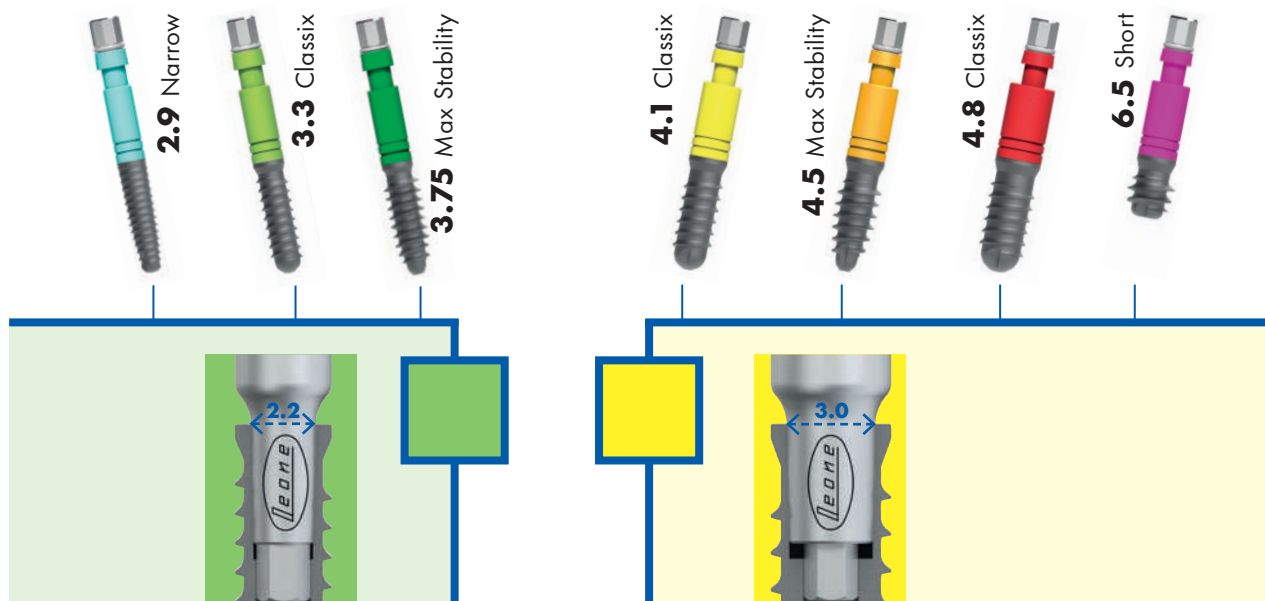

## COLOUR CODING OF THE PROSTHETIC CONNECTIONS

The XCN® implant system has only two prosthetic connections: small diameter implants have the 2.2 mm connection (colour code green), while implants with wider diameter have the 3.0 mm connection (colour code yellow).

## CLASSIX IMPLANTS

---

### Ideal for

---

- medium and high bone density
- limited horizontal bone availability
- crestal sinus lift

### Features

---

- made of medical grade 5 titanium
- flared coronal portion
- cylindrical geometry
- atraumatic thread design (Standard ISO 5835)
- two-lobed hemispherical apex
- 3 implant diameters (3.3 - 4.1 - 4.8 mm)
- 4 lengths (8 - 10 - 12 - 14 mm)

### Sterile package

---

- 1 implant mounted on carrier
- 1 cover cap in biopolymer







Classix implants **Ø 3.3 mm**  
connection diameter 2.2 mm colour code: green

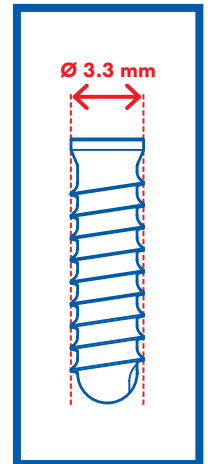

Ø (mm)  
length (mm)

3.3	3.3	3.3	3.3
8	10	12	14

REF **110-3308-02 110-3310-02 110-3312-02 110-3314-02**



Classix implants **Ø 4.1 mm**  
connection diameter 3.0 mm colour code: yellow

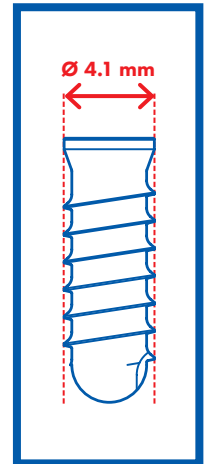

Ø (mm)  
length (mm)

4.1	4.1	4.1	4.1
8	10	12	14

REF **110-4108-02 110-4110-02 110-4112-02 110-4114-02**



Classix implants **Ø 4.8 mm**  
connection diameter 3.0 mm colour code: yellow

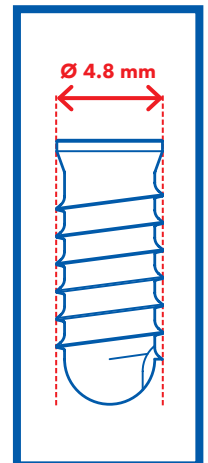

Ø (mm)  
length (mm)

4.8	4.8	4.8	4.8
8	10	12	14

REF **110-4808-30 110-4810-30 110-4812-30 110-4814-30**

## MAX STABILITY IMPLANTS

---

### Ideal for

---

- poor bone density
- immediate post-extraction implant placement
- immediate loading
- ridge split

### Features

---

- made of medical grade 5 titanium
- flared coronal portion
- root-form geometry
- over 50% increase in thread height
- two-lobed conical apex
- 2 implant diameters (3.75 - 4.5 mm)
- 4 lengths (8 - 10 - 12 - 14 mm)

### Sterile package

---

- 1 implant mounted on carrier
- 1 cover cap in biopolymer





Max Stability implants **Ø 3.75 mm**  
connection diameter 2.2 mm colour code: green

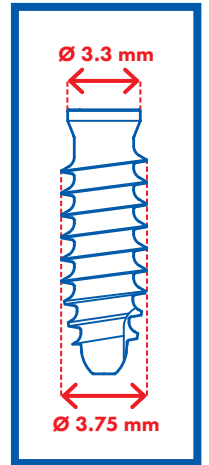

Ø (mm)  
length (mm)



3.75  
8



3.75  
10



3.75  
12



3.75  
14

1:1

REF **110-3808-02** **110-3810-02** **110-3812-02** **110-3814-02**

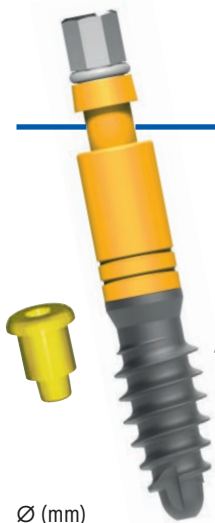

Max Stability implants **Ø 4.5 mm**  
connection diameter 3.0 mm colour code: yellow

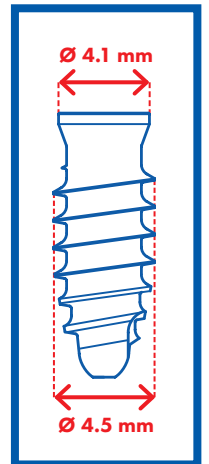

Ø (mm)  
length (mm)



4.5  
8



4.5  
10



4.5  
12



4.5  
14

1:1

REF **110-4508-02** **110-4510-02** **110-4512-02** **110-4514-02**

## 2.9 NARROW IMPLANTS

---

### Ideal for

---

- narrow ridges and limited interdental spaces
- upper lateral incisors
- lower central and lateral incisors

### Features

---

- made of medical grade 5 titanium
- cylindrical coronal portion
- conical geometry
- fine thread pitch
- tri-lobed conical apex
- implant diameter of 2.9 mm
- 3 lengths (10 - 12 - 14 mm)

### Sterile package

---

- 1 implant mounted on carrier
- 1 cover cap in biopolymer



## 6.5 SHORT IMPLANT

---

### Ideal for

---

- limited vertical bone availability

### Features

---

- made of medical grade 5 titanium
- flared coronal portion
- cylindrical geometry
- 125% increase in thread height
- two-lobed flat apex
- implant diameter of 5 mm
- length of 6.5 mm

### Sterile package

---



- 1 implant mounted on carrier
- 1 cover cap in biopolymer



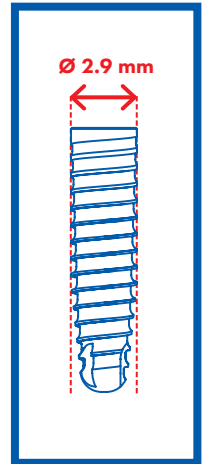

Narrow implants **Ø 2.9 mm**  
connection diameter 2.2 mm colour code: green



			
Ø (mm)	2.9	2.9	2.9
length (mm)	10	12	14
REF	<b>110-2910-02</b>	<b>110-2912-02</b>	<b>110-2914-02</b>



**6.5 Short** implant **Ø 5 mm**  
connection diameter 3.0 mm colour code: yellow

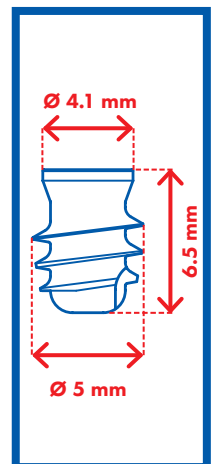

	
Ø (mm)	5
length (mm)	6.5
REF	<b>110-5065-02</b>

## TEMPLATE

To guide the clinician in the choice of the right implant: technical drawings show implants in 3 scales to match possible distortions created by the X-ray unit used for the radiographs:

- actual dimensions 1:1
- dimensions increased by 10%
- dimensions increased by 25%

REF **156-2003-00** Template for CLASSIX implants

REF **156-2003-02** Template for 6.5 SHORT implant

REF **156-2003-04** Template for MAX STABILITY implants

REF **156-2003-05** Template for 2.9 NARROW implants

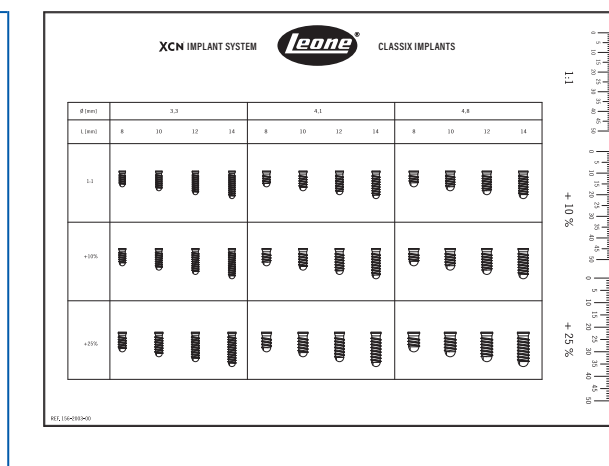

## LEONE IMPLANTS IN THE DIGITAL LIBRARIES

The Leone implant system is included in the libraries of the most popular dental software for implant treatment planning and 3D radiographic diagnostics. An updated list is available on Leone website [www.leone.it](http://www.leone.it) under section: implantology.

## ALL-ON-FOUR SURGICAL GUIDE

- made of stainless steel
- to guide the clinician in the angulation of implants in case of All-on-four or All-on-six techniques
- must be positioned in a hole created with the 2.2 mm pilot drill
- supplied non sterile

### Pack content:

- 1 guide
- 1 hex key



REF **156-2005-00**

## COMPATIBLE GUIDED SURGERY SYSTEMS

It is also possible to plan the surgery basing upon 3D images and perform the surgery with a surgical guide by means of the Leone "ZERO1" drill using the 3Shape Implant Studio software (a 3Shape registered trademark) or SICAT Implant.\*



\*For further details please contact your Leone dealer



**XCN<sup>®</sup> IMPLANT SYSTEM**

---

# SURGICAL INSTRUMENTS

# BURS AND DRILLS

## Features

- made of stainless steel with high resistance to wear and corrosion
- autoclavable



\*The drilling depth for pilot and twist drills is calculated not including the length of the tip (up to 1 mm max.).  
Replace drills used more than 20 times or in case of worn out cutting edges.

## LANCE DRILL ROUND BUR

- to mark the cortical bone  
for the subsequent drills

Pack of 1



Ø 1.9 mm

L 30 mm



Ø 1.9 mm

L 34 mm



REF

**151-1930-02**

**151-1934-01**

1:1

## PILOT DRILLS

- to create the pilot hole
- can also use short drills with depth stop

Pack of 1



Ø 2.2 mm

L 33 mm



Ø 2.2 mm

L 39 mm



REF

**151-2216-52**

**151-2222-42**

1:1

## TWIST DRILLS

- to allow the widening of the implant site up to the relevant size
- can also use short drills with depth stop

Pack of 1

Ø 2.8 mm

L 33 mm



Ø 2.8 mm

L 39 mm



Ø 3.5 mm

L 33 mm



Ø 3.5 mm

L 39 mm



Ø 4.2 mm

L 33 mm



Ø 4.2 mm

L 39 mm



REF

**151-2816-53**

**151-2822-43**

**151-3516-53**

**151-3522-43**

**151-4216-53**

**151-4222-43**

1:1

## TWIST DRILLS FOR HARD BONE

- specifically developed for Max Stability implants
- to avoid excessive insertion torque forces in case of hard bone
- **two colour-coded marks** to differentiate them from the other twist drills
- can also use short drills with depth stop

Pack of: 1



## COUNTERSINKS

- to shape the osteotomy for the flared coronal portion of the implant
- for use at the end of the surgical sequence

Pack of 1

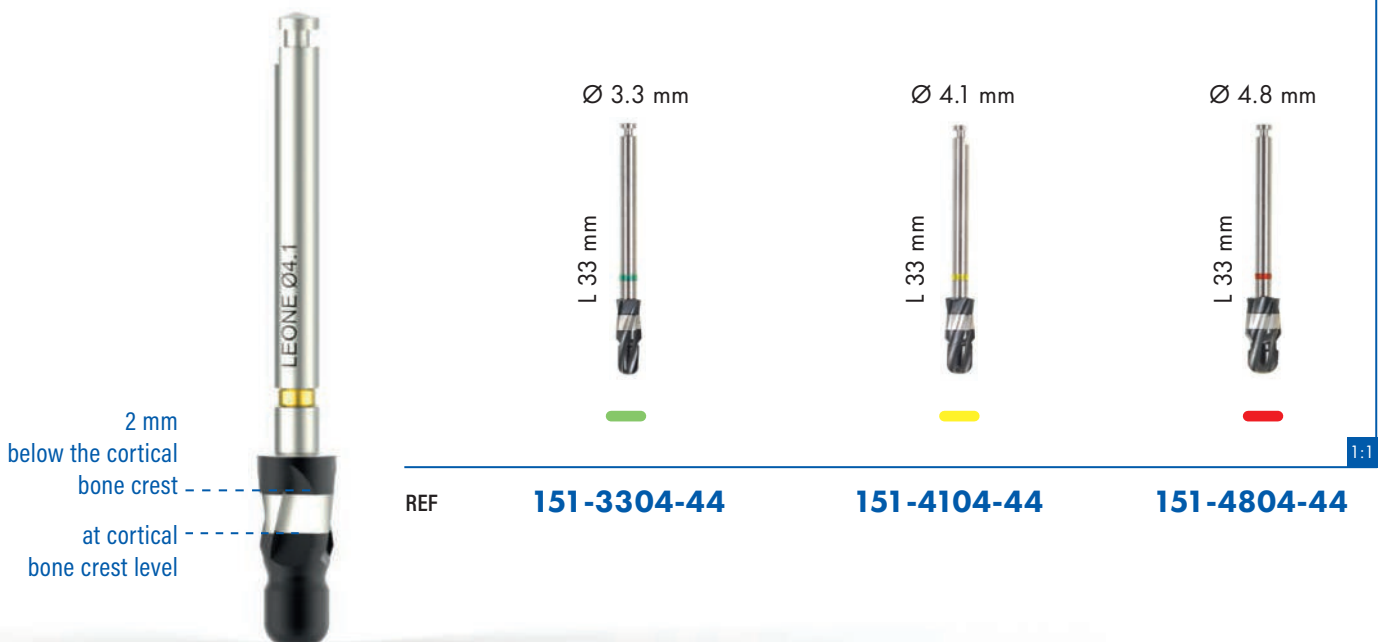

## DRILL STOP KIT\*

- kit made of aluminium
- depth stops made of medical grade 5 titanium
- for a reliable control of drilling depth during the implant site preparation
- for short pilot and twist drills
- drilling depth marked on each depth stop
- anodized stops for easy identification
- no-touch insertion of the depth stop directly from the drill tip with the help of the drill stop kit
- easy removal of the depth stop thanks to the specific slot in the drill stop kit
- fully autoclavable

### Pack content:

- 5 depth stops  $\varnothing$  2.2 mm:  
L 6.5 - L 8 - L 10 - L 12 - L 14 mm
- 5 depth stops  $\varnothing$  2.8/3.1 mm:  
L 6.5 - L 8 - L 10 - L 12 - L 14 mm
- 5 depth stops  $\varnothing$  3,5/3,8 mm:  
L 6.5 - L 8 - L 10 - L 12 - L 14 mm
- 5 depth stops  $\varnothing$  4.2 mm:  
L 6.5 - L 8 - L 10 - L 12 - L 14 mm
- 1 tool for stop removal



## DEPTH STOPS

- made of medical grade 5 titanium
- refills for drill stop kit
- autoclavable

### Pack content:

- 1 depth stop 6.5 mm
- 1 depth stop 8 mm
- 1 depth stop 10 mm
- 1 depth stop 12 mm
- 1 depth stop 14 mm



for drill

$\varnothing$  2.2 mm

$\varnothing$  2.8 mm  
 $\varnothing$  3.1 mm

$\varnothing$  3.5 mm  
 $\varnothing$  3.8 mm

$\varnothing$  4.2 mm

REF

**156-2216-05**

**156-2816-05**

**156-3516-05**

**156-4216-05**

## DRILL EXTENSION

- made of stainless steel
- allows to extend the total length of the drills
- autoclavable

### Pack of 1



REF **156-1019-00**

\*Patent pending

## TAPS FOR CLASSIX IMPLANTS

- made of stainless steel
- designed for the preparation of the implant site in case of high bone density
- colour-coded
- autoclavable

Pack of 1



REF **152-3321-00**    **152-4121-00**    **152-4821-00**

## TAPS FOR 6.5 SHORT IMPLANT

- made of stainless steel
- tap "A" for the preparation of implant site for 6.5 Short implant
- tap "B" for the preparation of implant site for 6.5 Short implant in case of high bone density after tapping with bone tap "A"
- two colour-coded marks differentiate tap "B" from tap "A"
- autoclavable

Pack of 1

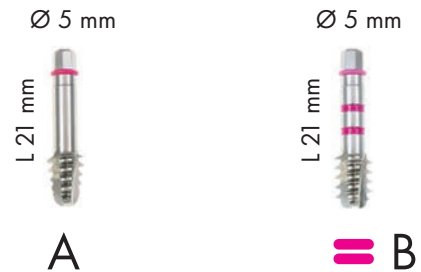





REF **152-5021-01**    **152-5021-02**

## CONNECTING RINGS

- made of elastomeric material
- replacement part for taps and instruments
- autoclavable

Pack of 5

-  REF **152-0000-01**
-  REF **152-0000-02**
-  REF **152-0000-03**
-  REF **152-0000-04**
-  REF **156-1002-02**

## HIGH TORQUE DRIVERS

- made of stainless steel
- to screw in or unscrew implants when the carrier is not strong enough to transmit the force applied
- two versions:
  - green** for 2.2 mm connection
  - yellow** for 3.0 mm connection
- can withstand torque up to 160 Ncm
- replace when used more than 50 times
- autoclavable

Pack of 1

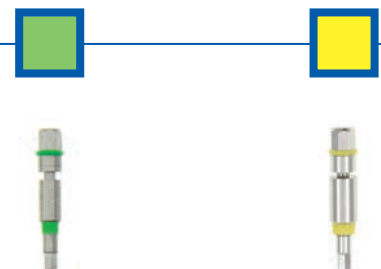

REF **156-1033-00**    **156-1041-00**



## HANDPIECE ADAPTER

- made of stainless steel
- to screw in or unscrew implants with the contra-angle handpiece
- to use taps with the contra-angle handpiece
- do not use with a torque value higher than 50 Ncm
- autoclavable

**Pack of 1**



1:1

REF **156-1002-01**

## EXTENSION FOR INSTRUMENTS

- made of medical grade 5 titanium
- to extend the overall length of carriers, drivers and taps
- autoclavable

**Pack of 1**



1:1

REF **156-1002-00**

## RATCHET

- made of medical grade 5 titanium
- for use with taps, carriers and drivers
- two-way function instrument to screw in or unscrew implants
- do not disassemble the instrument
- autoclavable

**Pack of 1**



1:1

REF **156-1014-00**

## SURGICAL HAND SCREWDRIVER

- made of medical grade 5 titanium
- for use with taps, carriers and drivers
- with a hole for the placement of a safety leash
- autoclavable

**Pack of 1**



1:1

REF **156-1001-01**

## PARALLELING PIN

- made of medical grade 5 titanium
- designed to ascertain parallelism of the implant site with natural teeth and/or with adjacent implant sites
- Ø 2.2 mm at one end, Ø 2.8 mm at the other end
- with a hole for the placement of a safety leash
- autoclavable

**Pack of 1**



1:1

REF **156-2001-00**

## DEPTH GAUGE

- made of medical grade 5 titanium
- designed to verify the depth of the implant site
- Ø 2.2 mm
- with a hole for the placement of a safety leash
- autoclavable

**Pack of 1**



1:1

REF **156-2002-00**

## INSTRUMENT FOR COVER CAPS

- made of medical grade 5 titanium
- designed for placement and removal of cover caps
- suitable for extraction of the healing cap GH 1.5 after unlocking
- with a hole for the placement of a safety leash
- autoclavable

**Pack of 1**



1:1

REF **156-1003-00**

## HEX HEAD EXTRACTOR FOR HEALING CAPS

- made of stainless steel
- to unlock the healing cap and thus permit its removal
- hexagon on both ends for easy use in all situations
- autoclavable

**Pack of 1**



1:1

REF **156-1006-00**

## TITANIUM BASIN

- made of medical grade 5 titanium
- safe support for titanium instruments or products
- autoclavable

**Pack of 1**



1:1

REF **156-1009-01**

## MEASURING PIN FOR GINGIVAL HEIGHT

- made of medical grade 5 titanium
- to detect the height of the soft tissues and parallelism of implant sites
- Ø 2.2 mm
- with a hole for the placement of a safety leash
- autoclavable

**Pack of 1**



1:1

REF **156-2004-00**

## MUCOSA PUNCH FOR CONTRA-ANGLE

- made of medical grade 5 titanium
- to punch the mucosa
- with colour code matching the implant diameter
- with references of depth and diameter
- autoclavable

Pack of 1

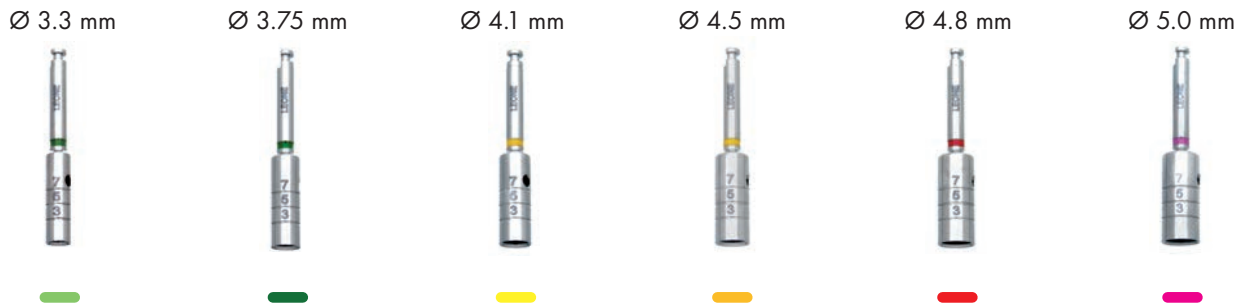

1:1

REF **154-3315-20**   **154-3815-20**   **154-4115-20**   **154-4515-20**   **154-4815-20**   **154-5015-20**

## BONE PROFILER

- made of stainless steel
- to remove bone coronally to the implant, when the bone walls are interfering with the abutment's emergence profile
- green guide pin for connection diameter 2.2 mm
- yellow guide pin for connection diameter 3.0 mm
- use the instrument for cover caps to insert and remove the guide pin from the implant
- Bone Profiler with diameter reference
- max speed: 50 rpm
- autoclavable

Pack of 1

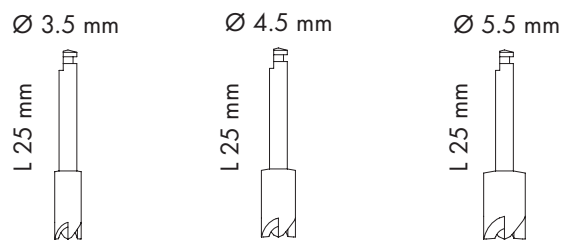

1:1

REF **151-3525-20**   **151-4525-20**   **151-5525-20**

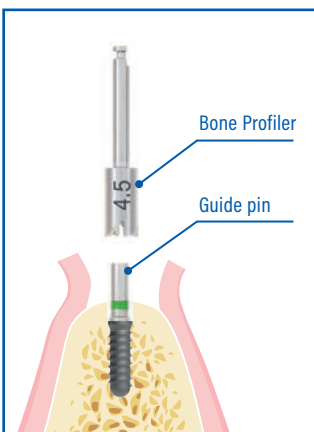

### GUIDE PIN

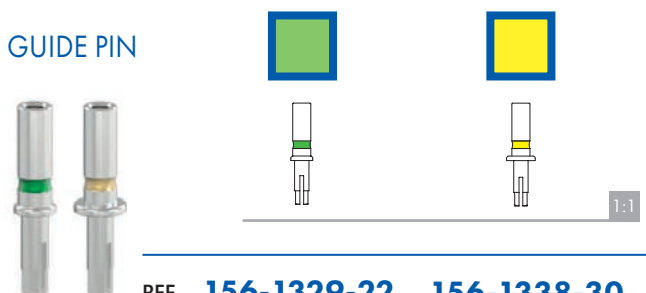

## SURGICAL KIT

### Features

- made of PPSU plastic material
- it includes all the surgical instruments required for treatment with the XCN® implant system
- space-saving
- easy and intuitive colour-coded system indicating the surgical sequence step-by-step for each implant
- tilted position after opening for easy access to instruments
- silicone grommets hold instruments firmly in place
- colour-coded depth stops placed within a special kit
- entirely autoclavable

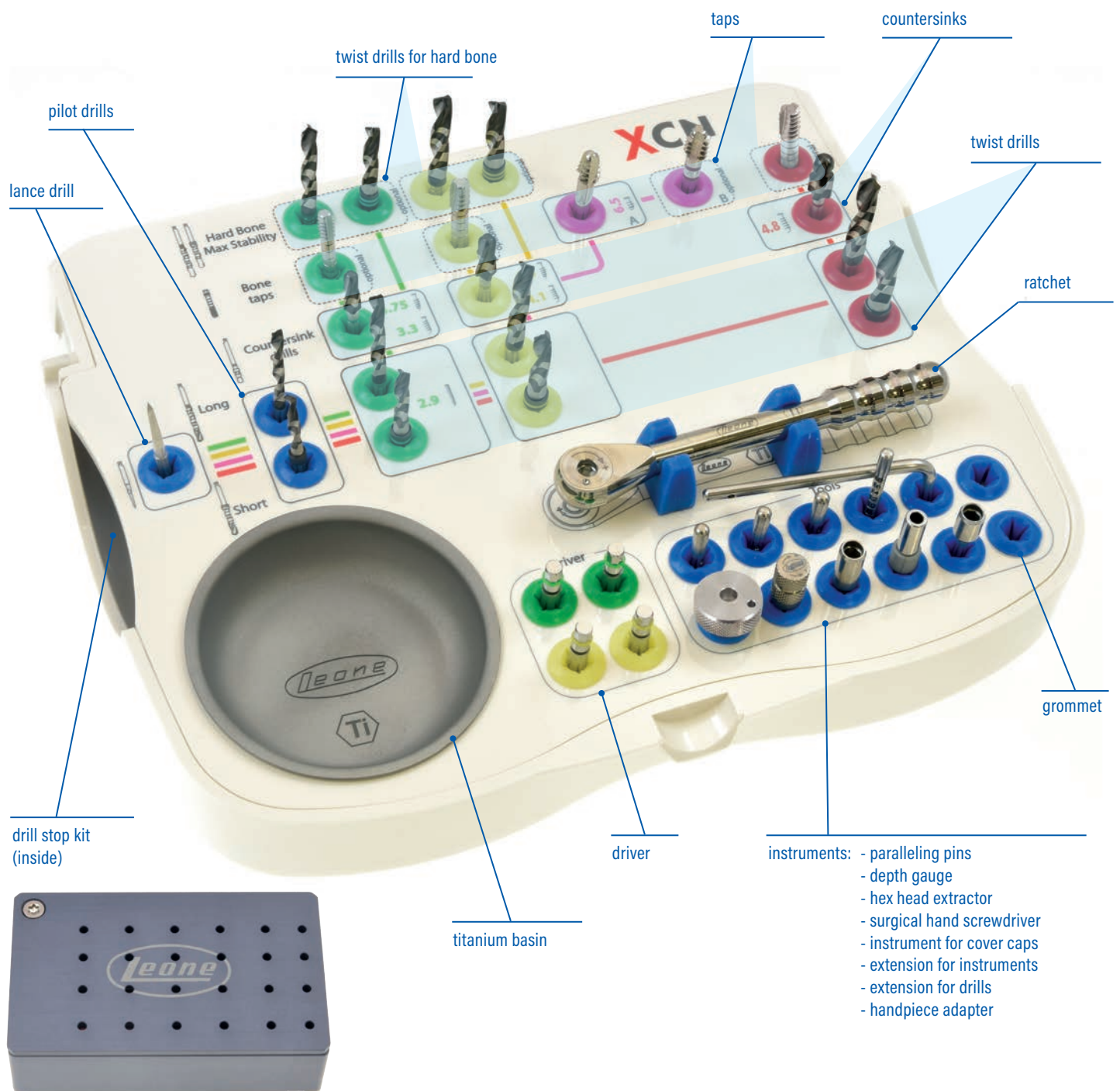

**COMPREHENSIVE  
SURGICAL KIT**

REF **156-0066-04**



**Kit content**

- 1 lance drill
- 2 pilot drills (short and long)
- 6 twist drills Ø 2.8-3.5-4.2 mm (short and long)
- 4 twist drills for hard bone Ø 3.1 e 3.8 mm (short and long) for Max Stability implants
- 3 countersinks Ø 3.3-4.1-4.8 mm
- 3 taps Ø 3.3-4.1-4.8 mm for Classix implants
- 2 taps Ø 5 mm A and B for 6.5 Short implant
- 2 High Torque drivers for connection 2.2 mm
- 2 High Torque drivers for connection 3.0 mm
- 3 paralleling pins Ø 2.2 mm
- 1 depth gauge Ø 2.2 mm
- 1 surgical hand screwdriver
- 1 extension for instruments
- 1 extension for drills
- 1 handpiece adapter
- 1 instrument for cover caps
- 1 hex head extractor
- 1 ratchet
- 1 titanium basin
- 1 drill stop kit
- 20 depth stops

**SURGICAL KIT  
SHORT DRILLS, INSTRUMENTS AND DRILL STOP KIT**

REF **156-0066-01**



**SURGICAL KIT  
SHORT DRILLS AND INSTRUMENTS**

REF **156-0066-11**



**SURGICAL KIT  
WITHOUT CONTENT**

REF **156-0066-00**



**GROMMETS**

- made of silicone
- refills for the surgical kit and the osteotomy kit
- autoclavable

	Ø 2 mm	REF <b>156-0002-02</b>	} Pack of 4
	Ø 2 mm	REF <b>156-0002-03</b>	
	Ø 2 mm	REF <b>156-0002-04</b>	
	Ø 2 mm	REF <b>156-0002-05</b>	
	Ø 2 mm	REF <b>156-0002-01</b>	
	Ø 4 mm	REF <b>156-0004-01</b>	} Pack of 2

## ORGANIZERS

---

### Features

---

- made of PPSU plastic material
- designed to sterilize and hold on the surgical field only the instruments necessary for the planned surgery
- extremely space-saving
- available in various types according to use (max 8 instruments)
- customizable by the clinician
- entirely autoclavable

### Package

---

- 1 tray
- with instruments mounted on colour-coded supports





**ORGANIZER**  
FOR CLASSIX IMPLANTS Ø 3.3 - 4.1 - 4.8

REF **156-0036-00**

- 151-1930-02 lance drill
- 151-2216-52 pilot drill short
- 151-2816-53 twist drill 2.8 short
- 151-3516-53 twist drill 3.5 short
- 151-4216-53 twist drill 4.2 short
- 151-3304-44 countersink 3.3
- 151-4104-44 countersink 4.1
- 151-4804-44 countersink 4.8

**ORGANIZER WITH TAPS**  
FOR CLASSIX IMPLANTS Ø 3.3 - 4.1 - 4.8

REF **156-0011-00**

- 152-3321-00 tap 3.3
- 152-4121-00 tap 4.1
- 152-4821-00 tap 4.8

**ORGANIZER**  
FOR MAX STABILITY IMPLANTS Ø 3.75 - 4.5

REF **156-0037-00**

- 151-1930-02 lance drill
- 151-2216-52 pilot drill short
- 151-2816-53 twist drill 2.8 short
- 151-3516-53 twist drill 3.5 short
- 151-3304-44 countersink 3.3
- 151-4104-44 countersink 4.1
- 151-3116-53 drill for hard bone 3.1 short
- 151-3816-53 drill for hard bone 3.8 short

**ORGANIZER**  
FOR 6.5 SHORT IMPLANT

REF **156-0038-65**

- 151-1930-02 lance drill
- 151-2216-52 pilot drill short
- 151-2816-53 twist drill 2.8 short
- 151-3516-53 twist drill 3.5 short
- 151-4104-44 countersink 4.1
- 152-5021-01 tap A
- 152-5021-02 tap B

**ORGANIZER**  
FOR 2.9 NARROW IMPLANTS

REF **156-0039-29**

- 151-1930-02 lance drill
- 151-2216-52 pilot drill short
- 151-2816-53 twist drill 2.8 short
- 151-3304-44 countersink 3.3

**ORGANIZER**  
FOR INSTRUMENTS

REF **156-0013-01**

- 156-1002-00 extension for instruments
- 156-1001-01 surgical hand screwdriver
- 156-1019-00 drill extension
- 156-1003-00 instrument for cover caps
- 156-1002-01 handpiece adapter
- 156-2002-00 depth gauge
- 156-1033-00 High Torque driver for connection 2.2
- 156-1041-00 High Torque driver for connection 3.0

**ORGANIZER**  
WITHOUT CONTENT

REF **156-0010-01**

## OSTEOTOMY INSTRUMENT KIT

REF 156-0040-00

### Features

- made of PPSU plastic material
- includes useful instruments for bone condensation techniques and maxillary sinus lift by crestal approach technique
- space-saving
- ergonomic: 9 different tips can be mounted on one single handle either in an upright or angled position
- silicone grommets hold instruments firmly in place
- 3 types of tips:
  - round cylindrical (for sinus lift)
  - convex-cylindrical-conical (for bone condensing)
  - concave-cylindrical-conical (for applying bone graft material)
- tips in 3 different diameters, with colour coding for an immediate identification
- offset adapter for easy use in posterior regions
- entirely autoclavable

### Package

- 2 threaded handles
- 1 surgical mallet
- 3 convex bone condenser tips Ø 2.7 - 3.4 - 4.1 mm
- 3 concave bone grafting tips Ø 2.7 - 3.4 - 4.1 mm
- 3 round sinus lift tips Ø 2.7 - 3.4 - 4.1 mm
- 1 tip wrench
- 1 offset adapter for threaded handle
- 1 titanium basin

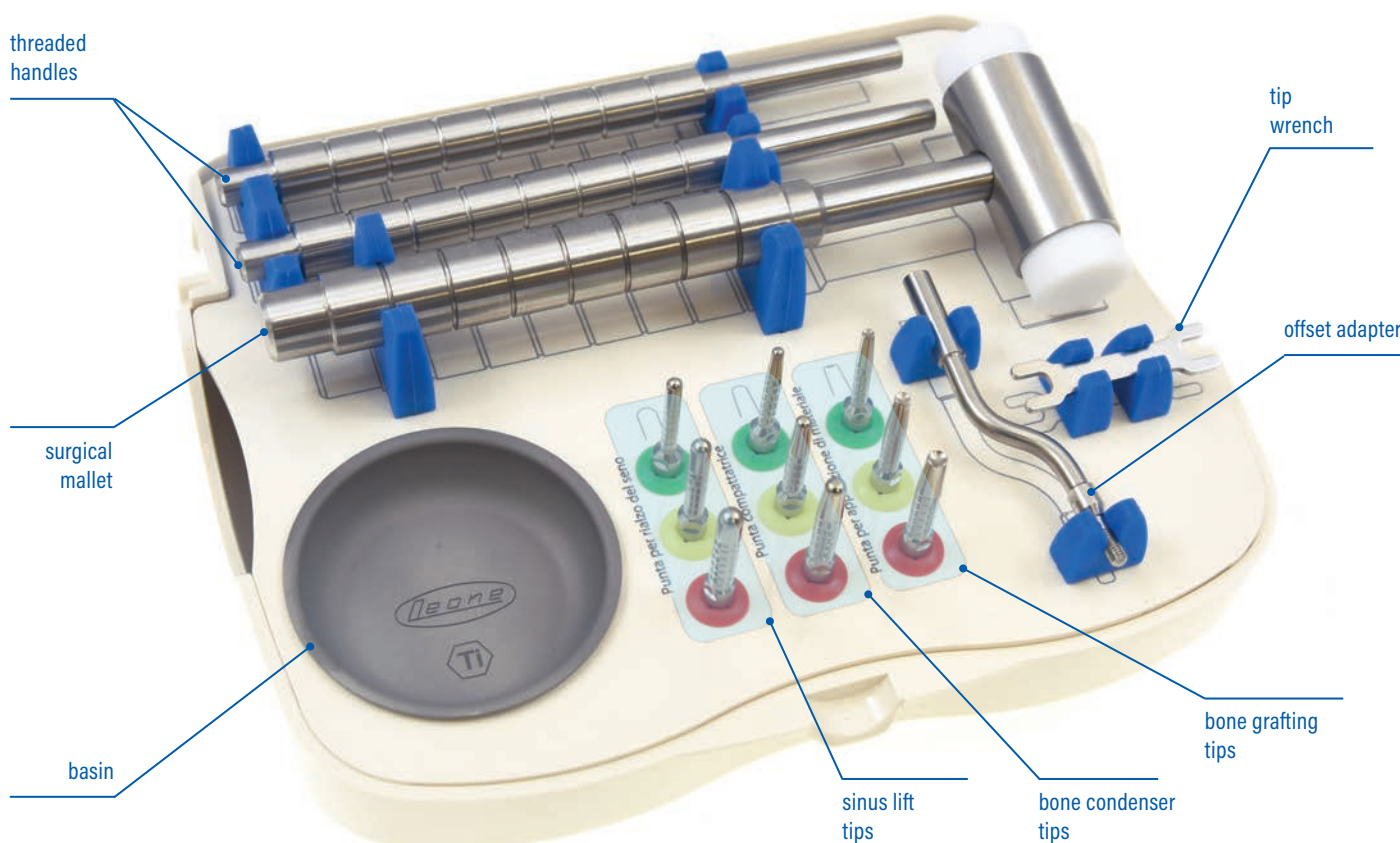

## SURGICAL TIPS

- for bone condensing techniques to increase primary stability of the implants and maxillary sinus lift by crestal approach
- with depth marks at 6.5 - 8 - 10 - 12 - 14 - 16 - 18 mm and colour coding

Pack of 1



### BONE CONDENSER TIPS

- made of medical grade 5 titanium
- cylindrical-conical with convex apex
- for atraumatic bone condensing
- for the greenstick fracture of the maxillary sinus floor
- autoclavable

Ø 2.7 mm



Ø 3.4 mm



Ø 4.1 mm



REF **156-1011-33** **156-1011-41** **156-1011-48**

1:1



### SINUS LIFT TIPS

- made of medical grade 5 titanium
- cylindrical shape with rounded apex
- to lift the sinus membrane without damage
- autoclavable

Ø 2.7 mm



Ø 3.4 mm



Ø 4.1 mm



REF **156-1010-33** **156-1010-41** **156-1010-48**

1:1



### BONE GRAFTING TIPS

- made of medical grade 5 titanium
- cylindrical-conical with concave apex
- to apply bone graft material during internal maxillary sinus lift
- for bone condensing
- autoclavable

Ø 2.7 mm



Ø 3.4 mm



Ø 4.1 mm



REF **156-1012-33** **156-1012-41** **156-1012-48**

1:1

## THREADED HANDLE

- made of stainless steel
- for use with surgical tips
- autoclavable

**Pack of 1**



1:1

REF **156-1008-00**

## OFFSET ADAPTER FOR THREADED HANDLE

- made of stainless steel
- for use with the threaded handle to allow the use of surgical tips in posterior regions
- autoclavable

**Pack of 1**



1:1

REF **156-1008-05**

## TIP WRENCH

- made of stainless steel
- for fixing the surgical tips onto the threaded handle and for their removal
- autoclavable

**Pack of 1**



1:1

REF **156-1008-07**

## SURGICAL MALLET

- made of stainless steel and Teflon
- for gentle tapping on the threaded handle for osteotomy techniques
- autoclavable

**Pack of 1**

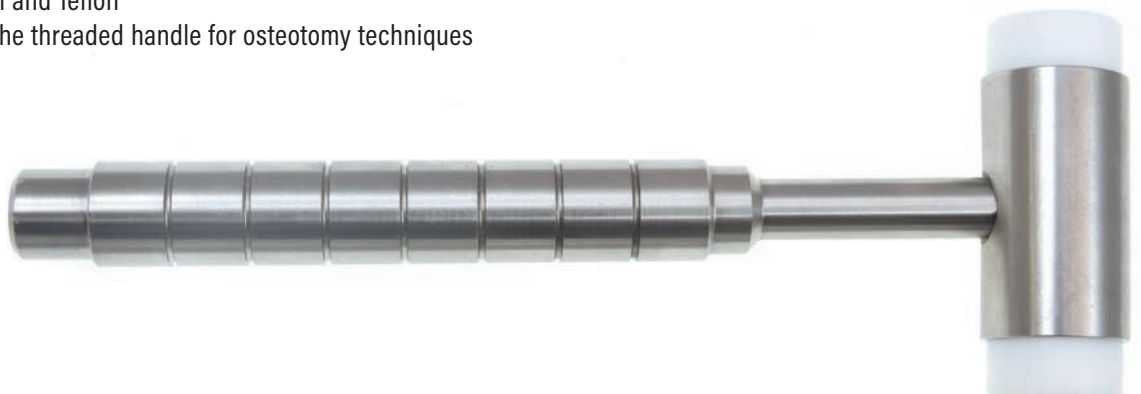

1:1

REF **156-1018-00**

# **XCN<sup>®</sup> IMPLANT SYSTEM**

---

PRODUCTS FOR  
SOFT TISSUE CONDITIONING  
AND PROSTHETIC COMPONENTS

## HEALING CAPS STANDARD AND LARGE



### Ideal for

- two-stage technique  
(insertion after a submerged implant healing period)
- one-stage technique  
(insertion immediately after implant placement for transgingival healing)

### Features

- made of medical grade 5 titanium
- for soft tissue contouring
- GH 1.5: can also be used instead of the cover cap in case of subcrestal implant placement

### Health of periimplant tissues

Due to the self-locking Morse taper connection, the gap between implant and healing cap is essentially zero and therefore the body recognizes the two elements as one single element. The absence of a micro gap also provides a hermetic barrier against bacterial infiltration as demonstrated by in-vitro studies. This promotes the clinical success of the one-stage technique documented by multiple clinical studies.

*Bibliography: www.leone.it in the section "Scientific publications"*

*Courtesy of Dr. L. Targetti*







### Necessary instruments

- selection of the most appropriate cap with the straight Abutment Gauge
- activation of the connection with the abutment seater with straight or offset titanium tip
- unlocking of the connection with the hex head extractor
- **GH 1.5:** after unlocking the connection with the hex head extractor, use the instrument for the cover caps for removal



### Sterile package

- 1 healing cap mounted on carrier





## Healing cap **standard**

					1:1
Ø connection (mm)	2.2	2.2	2.2	2.2	
Ø prosthetic platform (mm)	3.3	3.3	3.3	3.3	
GH (mm)	1.5	3	5	7	
REF	<b>133-3301-33</b>	<b>131-3303-33</b>	<b>131-3305-33</b>	<b>131-3307-33</b>	



## Healing cap **large**

				1:1
Ø connection (mm)	2.2	2.2	2.2	
Ø prosthetic platform (mm)	4.5	4.5	4.5	
GH (mm)	3	5	7	
REF	<b>131-3303-45</b>	<b>131-3305-45</b>	<b>131-3307-45</b>	

## Healing cap **standard**

					1:1
Ø connection (mm)	3.0	3.0	3.0	3.0	
Ø prosthetic platform (mm)	4.1	4.1	4.1	4.1	
GH (mm)	1.5	3	5	7	
REF	<b>133-4101-41</b>	<b>131-4103-41</b>	<b>131-4105-41</b>	<b>131-4107-41</b>	

## Healing cap **large**

				1:1
Ø connection (mm)	3.0	3.0	3.0	
Ø prosthetic platform (mm)	5.5	5.5	5.5	
GH (mm)	3	5	7	
REF	<b>131-4103-55</b>	<b>131-4105-55</b>	<b>131-4107-55</b>	

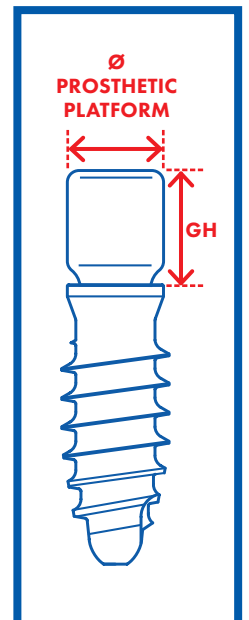

Specific products for soft tissue conditioning in case of screw-retained prostheses are also available:

- ExaConnect Plus for single-unit restorations (pages 59, 61)
- MUA Plus for multi-unit restorations (pages 67, 69).



## IMPLANT-ABUTMENT MORSE TAPER CONNECTION

Thanks to the combination of screwless self-locking Morse taper and the internal hexagon, the XCN® implant-abutment connection provides:

- outstanding resistance to masticatory forces
- very low percentage of prosthetic complications
- precise transfer of implant position between dental office and laboratory.

Bibliography: [www.leone.it](http://www.leone.it) in the section "Scientific publications"



## EXTRA-ORAL CEMENTATION

The XCN® connection system permits procedures that are not possible with screwed connection systems, such as extra-oral cementation, that eliminates the risks associated with excess cement remaining in the periimplant tissues.



Courtesy of Dr. S. Belcastro

## INDEXING OPTIONS

The system offers 3 different indexing options depending on the component selected: **with hexagon, without hexagon and with 360° hexagon.**

**Protected by international patents**, the XCN® 360° connection is the only system worldwide allowing for indexed abutments with no limits on positioning. This is possible due to the apical hexagon being independent from the rest of the abutment allowing for free positioning of 360°. In this way it is always easy to achieve parallelism, without losing the important index (hexagon).



## CONNECTION DIAMETERS AND COLOUR CODING

The connection diameter is the size of the abutment at the point where it emerges from the implant. Leone prosthetics is particularly simple since the system has only two connection diameters:

- 2.2 mm (green colour code) for small diameter implants
- 3.0 mm (yellow colour code) for implants with larger diameters.

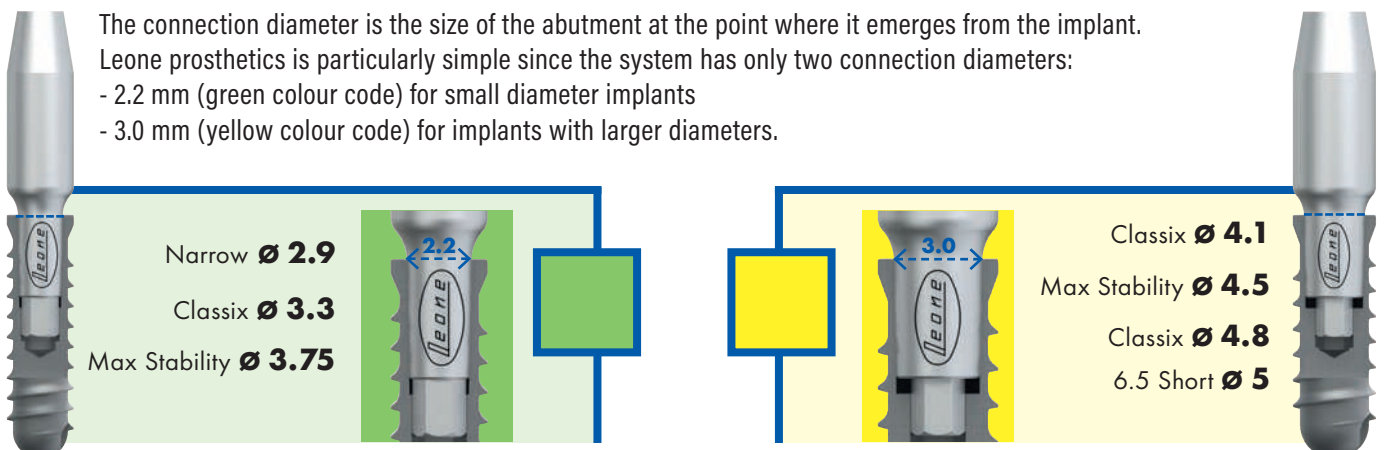

## STERILE PROSTHETIC COMPONENTS

The following prosthetic components are available sterile mounted on specific carriers to facilitate immediate loading and the one-stage surgical technique (transgingival healing):

- healing caps, Standard and Large
- ExaConnect Plus with the corresponding healing screw
- MUA Plus with the corresponding healing screw.

## CAD-CAM PROSTHETICS

The Leone implant system includes the accessories to fabricate cement-and screw-retained single crowns and bridges as well as bar-retained overdentures with the most widely used CAD-CAM software (3Shape Dental System, TRIOS 3Shape, Exocad DentalCAD and DWOS Dental Wings\*). An updated list of CAD-CAM software where Leone system may be found is available at: [www.leone.it](http://www.leone.it) under section implantology.



Courtesy of Technician M. Pisa

## PROSTHETIC VERSATILITY

The Leone implant system offers the possibility to fabricate cement-and screw-retained fixed restorations, fixed and removable conometric-retained restorations, as well as attachment-and bar-retained removable dentures.

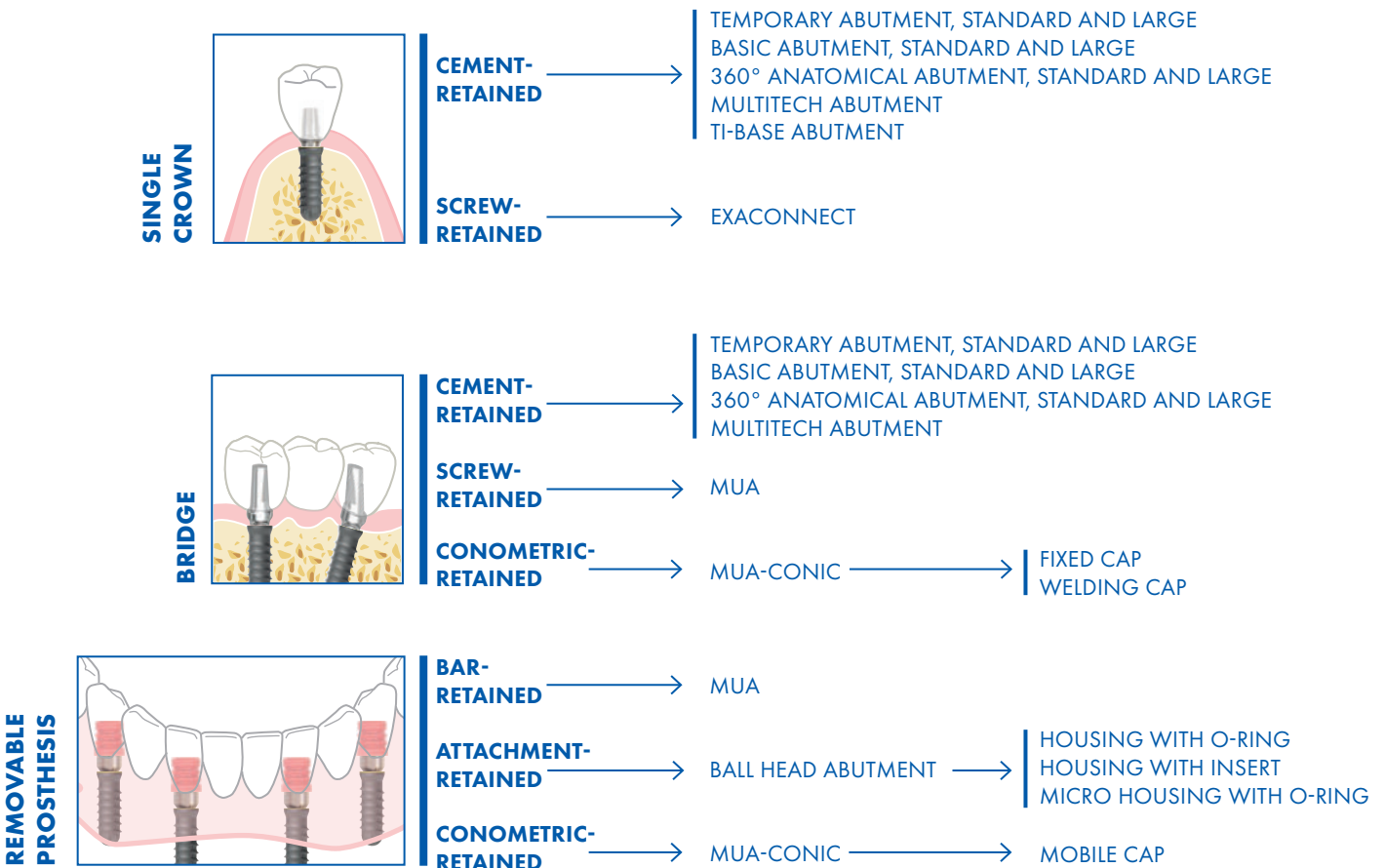

\*3Shape Dental System and TRIOS are trademarks of 3Shape, Exocad is a registered trademark of Exocad GmbH, DWOS and Dental Wings are registered trademarks of Dental Wings.



**2.9 Narrow**

**3.3 Classix**

**3.75 Max Stability**

**SOFT TISSUE CONDITIONING – STERILE PRODUCTS**

**UNIVERSAL**

HEALING CAPS



Standard

- GH 1.5
- GH 3
- GH 5
- GH 7

page 51



Large

- GH 3
- GH 5
- GH 7

page 35

**FOR SCREW-RETAINED PROSTHESIS ONLY**

EXACONNECT PLUS



page 59

- straight
- 7.5° angled
- 15° angled

- GH: 1.5 - 3 - 5

MUA PLUS



page 67

- straight
- 7.5° angled
- 15° angled
- 25° angled
- 35° angled

- GH: 1.5 - 3 - 5

**CEMENT-RETAINED PROSTHESIS**

**TRANSFER IMPLANT LEVEL**

**TRANSFER**



page 51

- Standard short
- Standard long
- Large

**SCAN POST AND SCAN BODY**



page 52

- Inclined plane
- Pyramid

**ANALOGS IMPLANT LEVEL**

**ANALOG**



page 51

- L 9 mm
- L 13 mm

**DIGITAL ANALOG**



page 53

**SCREW-RETAINED PROSTHESIS**

**ABUTMENTS**

**EXACONNECT**



page 58

- straight
- 7.5° - 15° angled

- GH: 1.5 - 3 - 5

**MUA**



page 66

- straight
- 7.5° - 15° - 25° - 35° angled

- GH: 1.5 - 3 - 5 - 7

**HEALING SCREWS ABUTMENT LEVEL**

**EXACONNECT HEALING SCREW**



page 60

**MUA HEALING SCREW**



page 68

**CONOMETRIC-RETAINED PROSTHESIS**

**ABUTMENTS**

**MUA-CONIC**



page 74, 76

- straight
- 7.5° - 15° - 25° - 35° angled

- GH: 1.5 - 3 - 5 - 7

**ATTACHMENT-RETAINED PROSTHESIS**

**ABUTMENTS**

**BALL HEAD**



page 82

- straight
- 15° angled

- GH: 1.5 - 3 - 5











**HOUSINGS**

**WITH O-RING**







page 84



## ABUTMENTS

TEMPORARY	BASIC	360° ANATOMICAL	MULTITECH	TI-BASE
 <p>page 44</p>	 <p>page 45</p>	 <p>pages 47, 48</p>	 <p>page 49</p>	 <p>page 50</p>
 <ul style="list-style-type: none"> <li>Standard and Large</li> <li>- straight</li> <li>- 15° angled</li> </ul>	 <ul style="list-style-type: none"> <li>Standard and Large</li> <li>- straight</li> <li>- 15° - 25° angled</li> </ul>	 <ul style="list-style-type: none"> <li>Standard and Large</li> <li>- straight</li> <li>- 15° - 25° angled</li> <li>- GH: 1 - 2 - 3 - 4</li> </ul>	 <ul style="list-style-type: none"> <li>- straight</li> </ul>  <ul style="list-style-type: none"> <li>- 15° angled</li> </ul>	 <ul style="list-style-type: none"> <li>- straight</li> </ul>

## TRANSFER ABUTMENT LEVEL

REPOSITIONABLE AND PICK-UP EXACONNECT	LAB AND SCAN TI-BASE AND SCAN BODY
 <p>page 60</p>	 <p>page 61</p> <ul style="list-style-type: none"> <li>- Inclined plane</li> <li>- Pyramid</li> </ul>
REPOSITIONABLE AND PICK-UP MUA	MUA SCAN BODY
 <p>page 68</p>	 <p>page 69</p>



## ANALOGS ABUTMENT LEVEL

EXACONNECT ANALOG	MUA ANALOG	MUA DIGITAL ANALOG
 <p>page 60</p>	 <p>page 68</p> <ul style="list-style-type: none"> <li>- straight</li> <li>- 15° angled</li> </ul>	 <p>page 69</p>

## PROSTHETIC SCREWS

EXACONNECT CONNECTING SCREWS	MUA CONNECTING SCREWS
 <p>page 62</p>	 <p>page 71</p> <ul style="list-style-type: none"> <li>- Standard</li> <li>- high head</li> </ul>

## COMPONENTS ABUTMENT LEVEL

EXACONNECT ABUTMENT	MUA CYLINDERS
 <p>pages 61, 62</p> <ul style="list-style-type: none"> <li>- temporary</li> <li>- Ti-Base</li> <li>- burn-out for Ti-Base</li> </ul>	 <p>pages 69, 70</p> <ul style="list-style-type: none"> <li>- CAD-CAM</li> <li>- for bonding</li> <li>- for welding</li> <li>- high burn-out</li> <li>- standard burn-out</li> </ul>

## CAPS

FIXED	MOBILE	WELDING
 <p>- made of PEEK for fixed prosthesis</p>	 <p>- made of PEEK for removable prosthesis</p>	 <p>page 77</p> <p>- made of titanium for welding techniques</p>



## HOUSINGS

WITH INSERT
 <p>page 83</p> <ul style="list-style-type: none"> <li>- with soft white insert</li> <li>- with medium orange insert</li> <li>- with rigid violet insert</li> </ul>

## MICRO HOUSINGS

WITH MICRO O-RING
 <p>page 84</p>

## O-RING REFILLS

O-RING	MICRO O-RING
	 <p>page 84</p>

## INSERT REFILLS

 <p>page 83</p> <ul style="list-style-type: none"> <li>- soft white</li> <li>- medium orange</li> <li>- rigid violet</li> </ul>
--



**SOFT TISSUE CONDITIONING – STERILE PRODUCTS**

**UNIVERSAL**

HEALING CAPS



Standard

- GH 1.5
- GH 3
- GH 5
- GH 7



Large

- GH 3
- GH 5
- GH 7

page 35

**FOR SCREW-RETAINED PROSTHESIS ONLY**

EXACONNECT PLUS



page 59

-  - straight
-  - 7.5° angled
-  - 15° angled

- GH: 1.5 - 3 - 5

MUA PLUS







page 67









-  - straight
-  - 7.5° angled
-  - 15° angled
-  - 25° angled
-  - 35° angled

- GH: 1.5 - 3 - 5



**CEMENT-RETAINED PROSTHESIS**

TRANSFER IMPLANT LEVEL		ANALOGS IMPLANT LEVEL	
TRANSFER	SCAN POST AND SCAN BODY	ANALOG	DIGITAL ANALOG
 <p>page 51</p> <ul style="list-style-type: none"> <li>- Standard short</li> <li>- Standard long</li> <li>- Large</li> </ul>	 <p>page 52</p> <ul style="list-style-type: none"> <li>- Inclined plane</li> <li>- Pyramid</li> </ul>	 <p>page 51</p> <ul style="list-style-type: none"> <li>- L 9 mm</li> <li>- L 13 mm</li> </ul>	 <p>page 53</p>





**SCREW-RETAINED PROSTHESIS**

ABUTMENTS		HEALING SCREWS ABUTMENT LEVEL	
<p style="text-align: center;">EXACONNECT</p> <div style="text-align: center;">  <p>page 58</p> </div> <ul style="list-style-type: none"> <li> - straight</li> <li> - 7.5° - 15° angled</li> </ul> <p style="text-align: center;">- GH: 1.5 - 3 - 5</p>		<p style="text-align: center;">EXACONNECT HEALING SCREW</p> <div style="text-align: center;">  <p>page 60</p> </div>	
<p style="text-align: center;">MUA</p> <div style="text-align: center;">  <p>page 66</p> </div> <ul style="list-style-type: none"> <li> - straight</li> <li> - 7.5° - 15° - 25° - 35° angled</li> </ul> <p style="text-align: center;">- GH: 1.5 - 3 - 5 - 7</p>		<p style="text-align: center;">MUA HEALING SCREW</p> <div style="text-align: center;">  <p>page 68</p> </div>	





**CONOMETRIC-RETAINED PROSTHESIS**

ABUTMENTS	
<p style="text-align: center;">MUA-CONIC</p> <div style="text-align: center;">  <p>Standard</p> <p>pages 74, 76</p> </div> <ul style="list-style-type: none"> <li> - straight</li> <li> - 7.5° - 15° - 25° - 35° angled</li> </ul> <p style="text-align: center;">- GH: 1.5 - 3 - 5 - 7</p>	



**ATTACHMENT-RETAINED PROSTHESIS**



ABUTMENTS		HOUSINGS	
<p style="text-align: center;">BALL HEAD</p> <div style="text-align: center;">  <p>Standard</p> <p>page 82</p> </div> <ul style="list-style-type: none"> <li> - straight</li> <li> - 15° angled</li> </ul> <p style="text-align: center;">- GH: 1.5 - 3 - 5</p>		<p style="text-align: center;">WITH O-RING</p> <div style="text-align: center;">  <p>page 84</p> </div>	

## ABUTMENTS

TEMPORARY	BASIC	360° ANATOMICAL	MULTITECH	TI-BASE
 <p>page 44</p> <ul style="list-style-type: none"> <li>Standard and Large</li> <li>- straight</li> <li>- 15° angled</li> </ul>	 <p>page 45</p> <ul style="list-style-type: none"> <li>Standard and Large</li> <li>- straight</li> <li>- 15° - 25° angled</li> </ul>	 <p>pages 47, 48</p> <ul style="list-style-type: none"> <li>Standard and Large</li> <li>- straight</li> <li>- 15° - 25° angled</li> <li>- GH: 1 - 2 - 3 - 4</li> </ul>	 <p>page 49</p> <ul style="list-style-type: none"> <li>- straight</li> <li>- 15° angled</li> </ul>	 <p>page 50</p> <ul style="list-style-type: none"> <li>- straight</li> </ul>



## TRANSFER ABUTMENT LEVEL

REPOSITIONABLE AND PICK-UP EXACONNECT	LAB AND SCAN TI-BASE AND SCAN BODY
 <p>page 60</p>	 <p>page 61</p> <ul style="list-style-type: none"> <li>- Inclined plane</li> <li>- Pyramid</li> </ul>

REPOSITIONABLE AND PICK-UP MUA	MUA SCAN BODY
 <p>page 68</p>	 <p>page 69</p>

## ANALOGS ABUTMENT LEVEL

EXACONNECT ANALOG
 <p>page 60</p>

MUA ANALOG	MUA DIGITAL ANALOG
 <p>page 68</p> <ul style="list-style-type: none"> <li>- straight</li> <li>- 15° angled</li> </ul>	 <p>page 69</p>

## PROSTHETIC SCREWS

EXACONNECT CONNECTING SCREWS
 <p>page 62</p>

MUA CONNECTING SCREWS
 <p>page 71</p> <ul style="list-style-type: none"> <li>- Standard</li> <li>- high head</li> </ul>

## COMPONENTS ABUTMENT LEVEL

EXACONNECT ABUTMENT
 <p>pages 61, 62</p> <ul style="list-style-type: none"> <li>- temporary</li> <li>- Ti-Base</li> <li>- burn-out for Ti-Base</li> </ul>

MUA CYLINDERS
 <p>pages 69, 70</p> <ul style="list-style-type: none"> <li>- CAD-CAM</li> <li>- for bonding</li> <li>- for welding</li> <li>- high burn-out</li> <li>- standard burn-out</li> </ul>

## CAPS

FIXED	MOBILE	WELDING
 <p>page 77</p> <ul style="list-style-type: none"> <li>- made of PEEK for fixed prosthesis</li> </ul>	 <p>page 77</p> <ul style="list-style-type: none"> <li>- made of PEEK for removable prosthesis</li> </ul>	 <p>page 77</p> <ul style="list-style-type: none"> <li>- made of titanium for welding techniques</li> </ul>



## HOUSINGS

WITH INSERT
 <p>page 83</p> <ul style="list-style-type: none"> <li>- with soft white insert</li> <li>- with medium orange insert</li> <li>- with rigid violet insert</li> </ul>

## MICRO HOUSINGS

WITH MICRO O-RING
 <p>page 84</p>

## O-RING REFILLS

O-RING	MICRO O-RING
	 <p>page 84</p>

## INSERT REFILLS

 <p>page 83</p> <ul style="list-style-type: none"> <li>- soft white</li> <li>- medium orange</li> <li>- rigid violet</li> </ul>
--





**XCN<sup>®</sup> IMPLANT SYSTEM**

---

ABUTMENTS FOR  
CEMENT-RETAINED PROSTHESIS  
AND IMPRESSION ACCESSORIES

## TEMPORARY ABUTMENTS STANDARD AND LARGE







### Features

- made of PEEK
- for provisional prostheses
- for temporary use only, max. 180 days
- radiolucent
- autoclavable

Pack of 1

### Necessary instruments

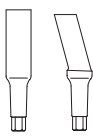
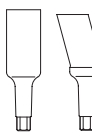
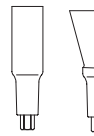
- selection of the most appropriate temporary abutment with the Abutment Gauges
- **straight abutments:** activation of the connection with the abutment seater with straight or offset titanium tip
- **angled abutments:** activation of the connection with the abutment seater with flat tip
- removal with extraction pliers

				
	standard	large	standard	large
				
Ø connection (mm)	2.2	2.2	3.0	3.0
Ø prosthetic platform (mm)	3.3	4.5	4.1	5.5
REF	straight 15° angled	<b>161-3310-00</b> <b>161-3310-15</b>	<b>161-4110-00</b> <b>161-4110-15</b>	<b>161-5510-00</b> <b>161-5510-15</b>

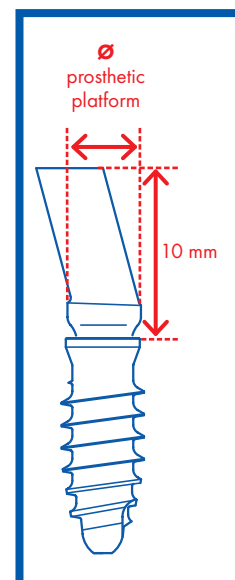

## BASIC ABUTMENTS STANDARD AND LARGE





### Features

- made of medical grade 5 titanium
- ideal for vertical (feather-edge) preparation technique
- **Standard:** suitable for soft tissues with at least 2 mm thickness
- **Large:** suitable for soft tissues with at least 2.5 mm thickness

Pack of 1

### Necessary instruments

- selection of the most appropriate Basic Abutment with the Abutment Gauges
- **straight abutments:** activation of the connection with the abutment seater with straight or offset titanium tip
- **angled abutments:** activation of the connection with the abutment seater with flat tip

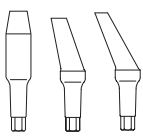
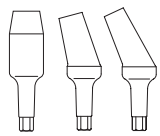
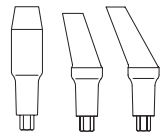
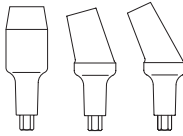
				
	standard	large	standard	large
				
Ø connection (mm)	2.2	2.2	3.0	3.0
Ø prosthetic platform (mm)	3.3	4.5	4.1	5.5
REF	straight <b>120-3310-33</b> 15° angled <b>124-3303-01</b> 25° angled <b>124-3303-02</b>	straight <b>120-3310-45</b> 15° angled <b>124-3303-03</b> 25° angled <b>124-3303-04</b>	straight <b>120-4110-41</b> 15° angled <b>124-4103-01</b> 25° angled <b>124-4103-02</b>	straight <b>120-4110-55</b> 15° angled <b>124-4103-03</b> 25° angled <b>124-4103-04</b>

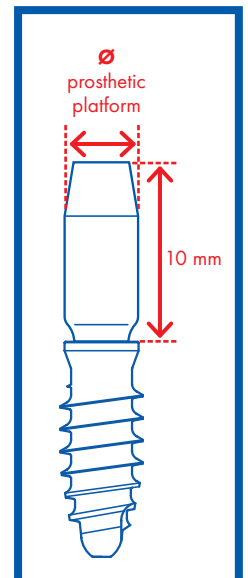

## 360° ANATOMICAL ABUTMENTS STANDARD AND LARGE



### Step

- parallel to the implant axis on all angled abutments, for correct activation of the connection

### 2 opposite plain faces

- to improve the retention of crowns

### Preformed abutment shoulder

- in 4 gingival heights (GH)

### XCN® 360° connection

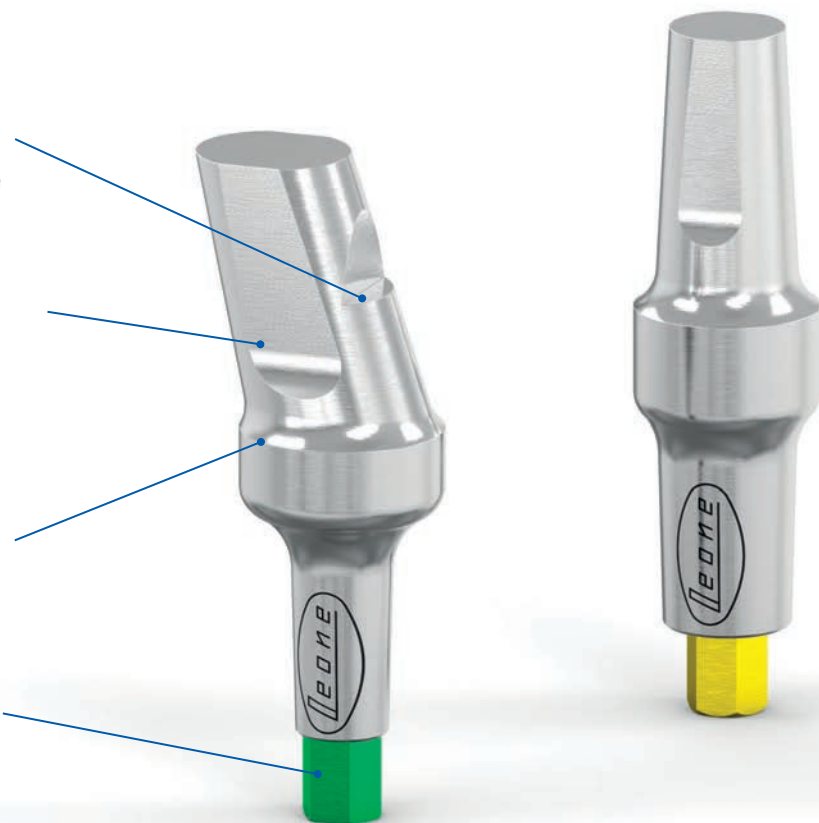

## Features

- made of medical grade 5 titanium
- ready to use, no or only limited need of preparation
- autoclavable

## Necessary instruments

- selection of the most appropriate 360° abutment with the Abutment Gauges
- **straight abutments:** activation of the connection with the abutment seater with straight or offset titanium tip
- **angled abutments:** activation of the connection with the abutment seater with flat tip

## Pack content

- 1 abutment
- 1 hexagon

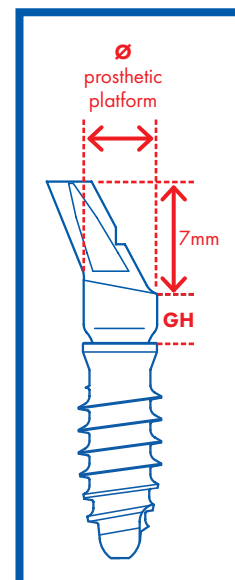

### 360° Anatomical abutments **standard**

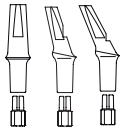
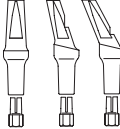
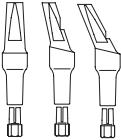
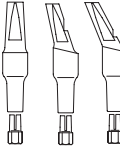
							1:1
Ø connection (mm)			2.2	2.2	2.2	2.2	
Ø prosthetic platform (mm)			3.3	3.3	3.3	3.3	
GH (mm)			1	2	3	4	
REF	straight	<b>129-3300-03</b>	<b>129-3301-00</b>	<b>129-3302-00</b>	<b>129-3303-00</b>		
	15° angled	<b>129-3300-01</b>	<b>129-3301-01</b>	<b>129-3302-01</b>	<b>129-3303-01</b>		
	25° angled	<b>129-3300-02</b>	<b>129-3301-02</b>	<b>129-3302-02</b>	<b>129-3303-02</b>		

### 360° Anatomical abutments **large**

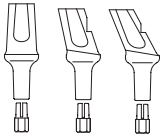
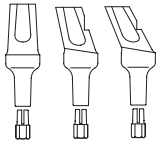
					1:1
Ø connection (mm)			2.2	2.2	
Ø prosthetic platform (mm)			4.5	4.5	
GH (mm)			2	3	
REF	straight		<b>129-4501-00</b>	<b>129-4502-00</b>	
	15° angled		<b>129-4501-01</b>	<b>129-4502-01</b>	
	25° angled		<b>129-4501-02</b>	<b>129-4502-02</b>	

### 360° Anatomical abutments **standard**

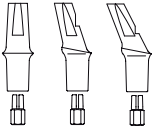
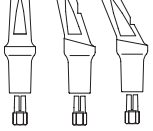
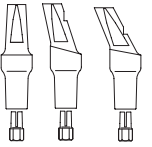
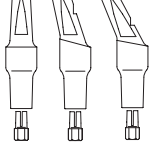
														1:1
Ø connection (mm)		3.0			3.0			3.0			3.0			
Ø prosthetic platform (mm)		4.1			4.1			4.1			4.1			
GH (mm)		1			2			3			4			
REF	straight	<b>129-4100-03</b>	<b>129-4101-00</b>	<b>129-4102-00</b>	<b>129-4103-00</b>									
	15° angled	<b>129-4100-01</b>	<b>129-4101-01</b>	<b>129-4102-01</b>	<b>129-4103-01</b>									
	25° angled	<b>129-4100-02</b>	<b>129-4101-02</b>	<b>129-4102-02</b>	<b>129-4103-02</b>									



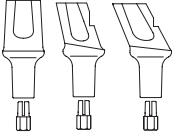
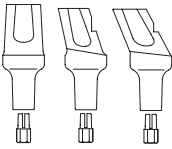

### 360° Anatomical abutments **large**

								1:1
Ø connection (mm)		3.0			3.0			
Ø prosthetic platform (mm)		5.5			5.5			
GH (mm)		2			3			
REF	straight	<b>129-5501-00</b>	<b>129-5502-00</b>					
	15° angled	<b>129-5501-01</b>	<b>129-5502-01</b>					
	25° angled	<b>129-5501-02</b>	<b>129-5502-02</b>					

### HEXAGONS FOR 360° ABUTMENTS

- made of medical grade 5 titanium
- refill for abutments with XCN® 360° connection
- autoclavable

**Pack of 2**

		
		
for abutments with Ø connection (mm)	2.2	3.0
REF	<b>129-3300-00</b>	<b>129-4100-00</b>

## MULTITECH ABUTMENTS

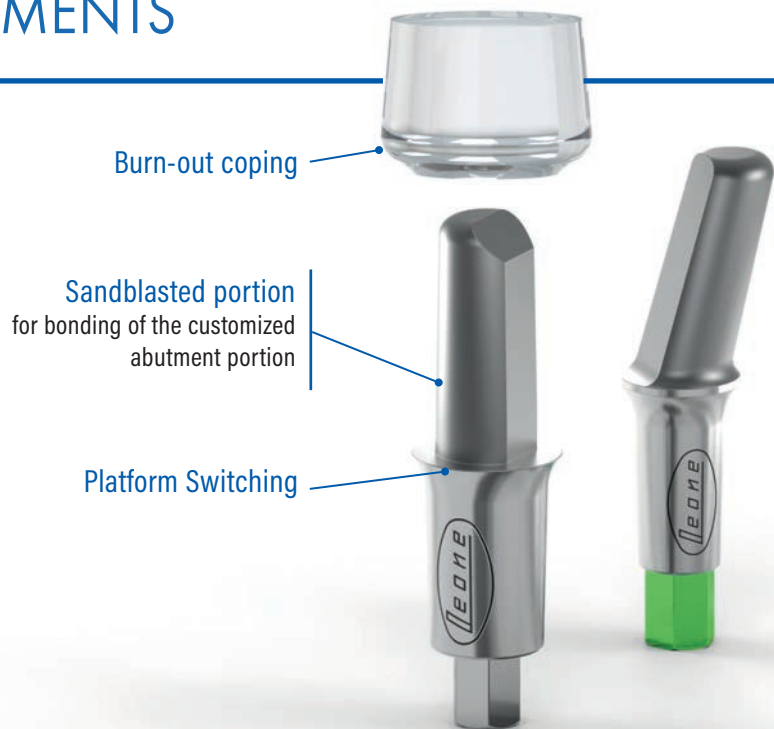
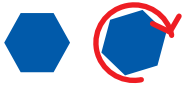

### Features

- made of medical grade 5 titanium
- to fabricate a fully patient-customized abutment by creating an abutment portion to be bonded onto MultiTech
- to fabricate a customized abutment portion with CAD-CAM technology or with the traditional method by using the burn-out coping

**Pack content:** 1 abutment, 1 hexagon (for the angled abutments only), 2 burn-out copings

### Necessary instruments

- selection of the most appropriate MultiTech abutment with the Abutment Gauges
- **straight abutments:** activation of the connection with the abutment seater with straight or offset PEEK tip
- **angled abutments with customized metal or zirconia portion:** activation of the connection with the abutment seater with flat tip

1:1

∅ connection (mm) 2.2

∅ prosthetic platform (mm) 2.9

REF straight **121-3306-00**

15° angled **121-3306-15**

1:1

∅ connection (mm) 3.0

∅ prosthetic platform (mm) 3.7

**121-4106-00**

**121-4106-15**

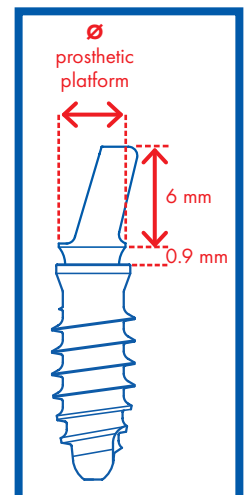



# TI-BASE ABUTMENTS



## Features

- made of medical grade 5 titanium
- to create a monolithic dental crown with CAD-CAM technology
- to fabricate a fully patient-customized abutment by creating an abutment portion with CAD-CAM technology to be bonded onto Ti-Base
- coronal portion suitable for S blocks specific for CAM milling
- autoclavable

Pack of 1



Courtesy of M. Pisa



## Necessary instruments

- **straight ceramic restorations:**  
activation of the connection with the abutment seater with straight or offset PEEK tip
- **angled ceramic restorations:**  
activation through the hole of the block (with the long bar supplied with the analog package)

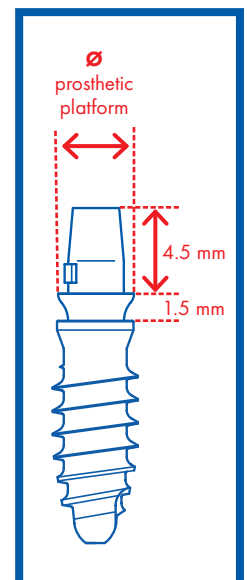
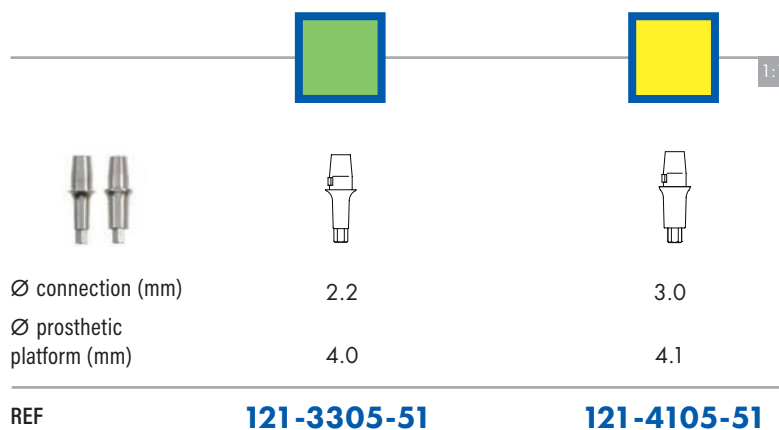









## TRANSFERS STANDARD AND LARGE

- made of stainless steel
- to take an impression at implant level with a closed impression tray
- colour-coded
- autoclavable

Pack of 1



	standard		large
			
Ø connection (mm)	2.2	2.2	2.2
Ø prosthetic platform (mm)	3.3	3.3	4.5
GH (mm)	5	8	5
REF	<b>141-3305-33</b>	<b>141-3308-33</b>	<b>141-3305-45</b>

	standard		large
			
Ø connection (mm)	3.0	3.0	3.0
Ø prosthetic platform (mm)	4.1	4.1	5.5
GH (mm)	5	8	5
REF	<b>141-4105-41</b>	<b>141-4108-41</b>	<b>141-4105-55</b>

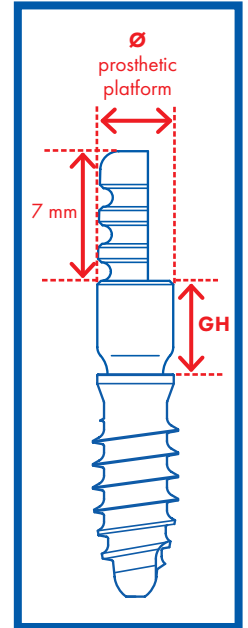

## POSITIONER FOR STANDARD TRANSFER

- made of stainless steel
- to place the transfer into the implant in hard-to-reach areas
- with a hole for the placement of a safety leash
- autoclavable

Pack of 1

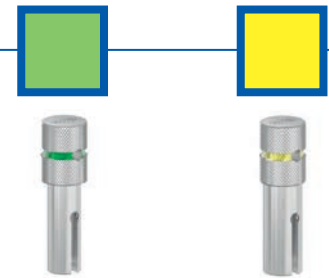

REF **141-0001-33** **141-0001-41**







## ANALOGS

- made of stainless steel
- to replicate the position of the implant in the dental cast
- available in two versions: standard and long
- colour-coded

Pack content:

- 1 analog
- 1 pin
- 1 bar for the removal of the abutment



				
Ø connection (mm)				
	2.2		3.0	
REF	L 9 mm	<b>142-3309-00</b>	L 13 mm	<b>142-4109-00</b>
		<b>142-3313-00</b>		<b>142-4113-00</b>

## SCAN POST AND SCAN BODIES INCLINED PLANE AND PIRAMID

- **Scan Post:** made of stainless steel
- **Scan Bodies:** made of plastic material
- to take a digital impression at implant level in the mouth or to digitize the dental cast in the laboratory
- autoclavable

**Pack content:**

**Inclined plane**

- 1 Scan Post
- 3 white Scan Bodies Inclined Plane

**Piramid**

- 1 Scan Post
- 3 white Scan Bodies Piramid
- 3 grey Scan Bodies Piramid

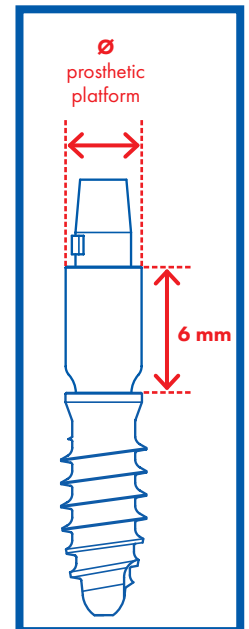
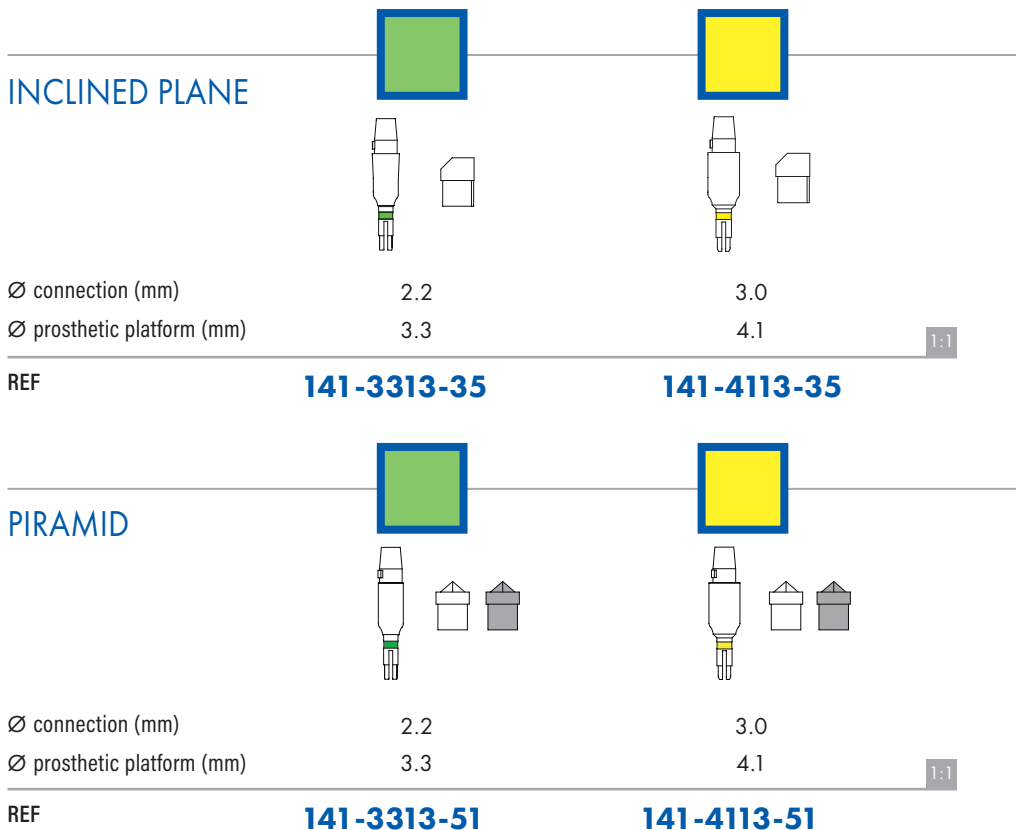

## SCAN BODY INCLINED PLANE

- made of plastic material
- for Scan Post and Ti-Base
- autoclavable

**Pack of 5 (white)**



## SCAN BODIES PIRAMID

- made of plastic material
- for Scan Post and Ti-Base
- autoclavable

**Pack of 10 (5 white and 5 grey)**



## SCAN POST POSITIONER

- made of stainless steel
- to place the Scan Post into the implant
- with a hole for the placement of a safety leash
- autoclavable

**Pack of 1**



1:1

REF **141-0001-51**

## DIGITAL ANALOGS

- made of stainless steel
- to be positioned inside a rapid prototyping dental cast originated from an intraoral digital impression
- colour-coded

**Pack content:**

- 1 analog
- 1 positioner for analogs
- 2 pins for the stabilization within the cast
- 1 bar for the removal of the abutment



Ø connection (mm)

L 9 mm



2.2

L 9 mm



3.0

1:1

REF

**142-2209-54 142-3009-54**



**XCN** IMPLANT SYSTEM

---

EXACONNECT  
FOR SCREW-RETAINED  
PROSTHESIS  
AND ACCESSORIES

## EXACONNECT

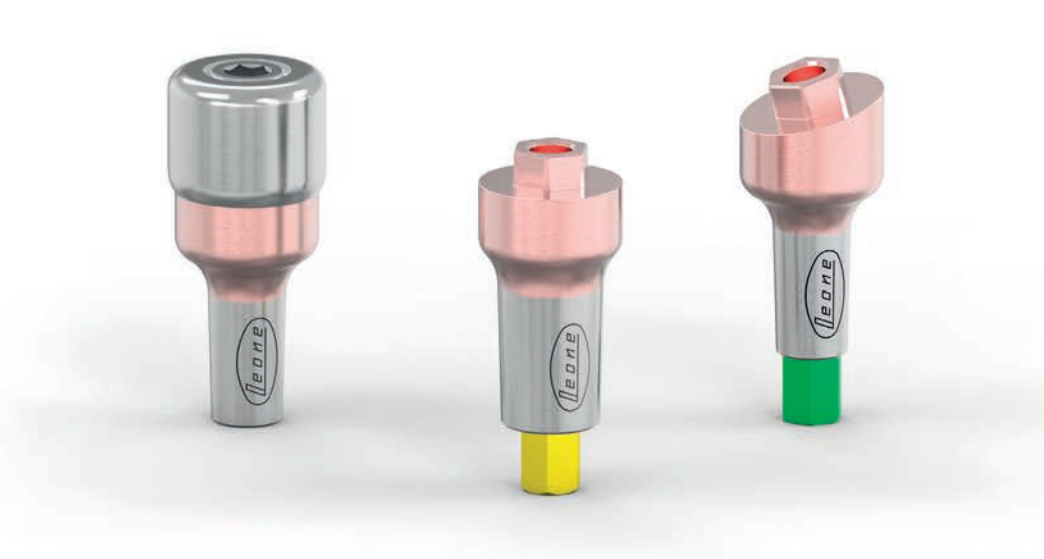

### Ideal for

- single screw-retained crowns
- transgingival healing (with the corresponding healing screw)
- immediate loading

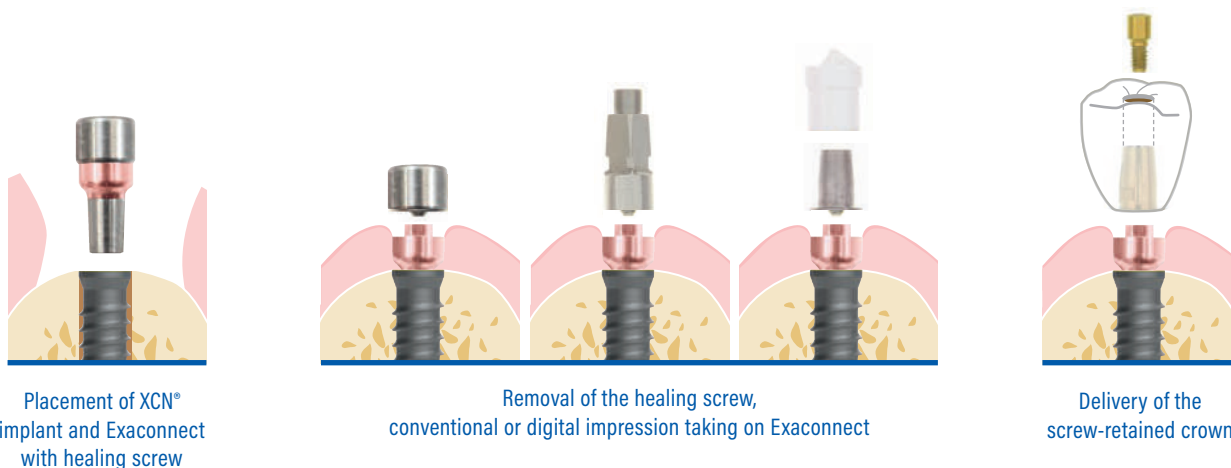

Placement of XCN®  
implant and Exaconnect  
with healing screw

Removal of the healing screw,  
conventional or digital impression taking on Exaconnect

Delivery of the  
screw-retained crown

### Features

- made of medical grade 5 titanium
- top with external hexagon for the connection of a screw-retained crown
- pink anodized
- **ExaConnect:** autoclavable  
delivered mounted on a multifunctional screw for easy positioning and orientation in the dental cast
- **ExaConnect Plus:** sterile  
delivered mounted on a carrier for easy positioning and orientation in the implant



## Prosthetic simplicity

ExaConnect facilitates the prosthetic procedure since it shifts the prosthetic platform from the bone level to the soft tissue level. **A great advantage in cases of very thick mucosa or deep implant position.** Impression taking and fabrication of the prosthesis are done on the ExaConnect.

It also features the same prosthetic platform for all implant diameters.

## Prosthetic flexibility

ExaConnect fits any clinical situation due to the XCN 360° connection.

The movable hexagon allows for 360° positioning on the dental cast making it easy to achieve parallelism.

The permanent connection of the hexagon in the selected position allows an accurate positioning of the abutment in the mouth.

## External hexagon with zero tolerance

The innovative design of the external hexagon of the connector ensures a perfect fit that eliminates micro movements between the components and reduces abutment screw loosening.

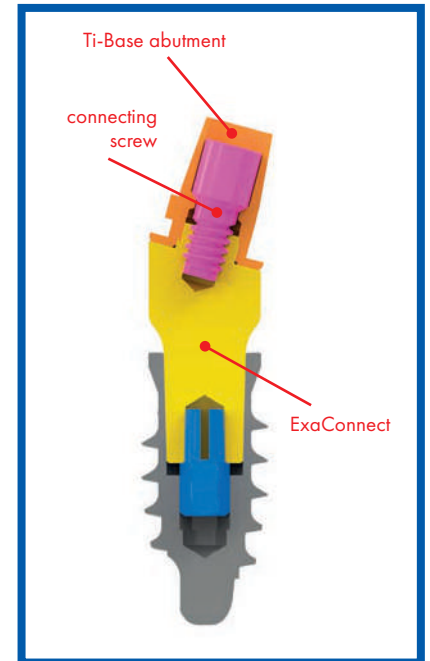

## EXACONNECT PLUS - sterile

The ExaConnect Plus is designed for insertion immediately after implant placement.

It is delivered mounted on a carrier that facilitates its placement and orientation in the implant.

The connector has no index (hexagon) and thus can rotate freely.

The pre-mounted healing screw allows soft tissue conditioning with the angulation of the selected connector enhancing natural aesthetics. Aesthetics is further improved by the anodization of the ExaConnect.

Once ExaConnect has been connected to the implant, it is no longer necessary to remove it, as impression taking and fabrication of the prosthesis are done on the Exaconnect.

Thanks to the self-locking Morse taper connection between ExaConnect and the implant, the body recognizes the two elements as one single element becoming the **equivalent of a transmucosal implant.**

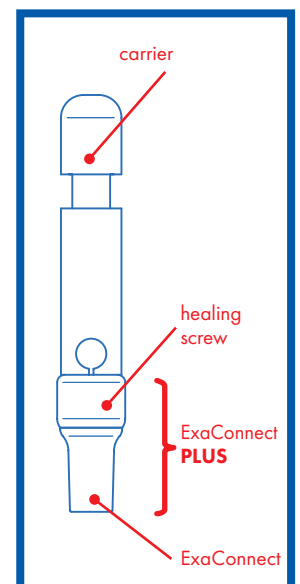

# EXACONNECT



## Necessary instruments

- selection of the most appropriate ExaConnect with the Abutment Gauges
- activation of the connection with the abutment seater with straight or offset PEEK tip

## Package

- 1 ExaConnect mounted on multifunctional screw
- 1 hexagon

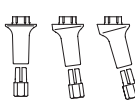
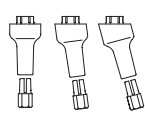
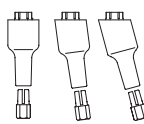

### ExaConnect

				
Ø connection (mm)	2.2	2.2	2.2	
GH (mm)	1.5	3	5	
REF	straight 7.5° angled 15° angled	<b>126-2201-01</b> <b>126-2201-07</b> <b>126-2201-15</b>	<b>126-2203-01</b> <b>126-2203-07</b> <b>126-2203-15</b>	<b>126-2205-01</b> <b>126-2205-07</b> <b>126-2205-15</b>

### ExaConnect

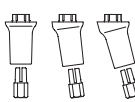
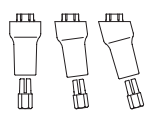
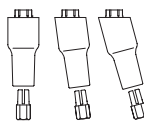
				
Ø connection (mm)	3.0	3.0	3.0	
GH (mm)	1.5	3	5	
REF	straight 7.5° angled 15° angled	<b>126-3001-01</b> <b>126-3001-07</b> <b>126-3001-15</b>	<b>126-3003-01</b> <b>126-3003-07</b> <b>126-3003-15</b>	<b>126-3005-01</b> <b>126-3005-07</b> <b>126-3005-15</b>

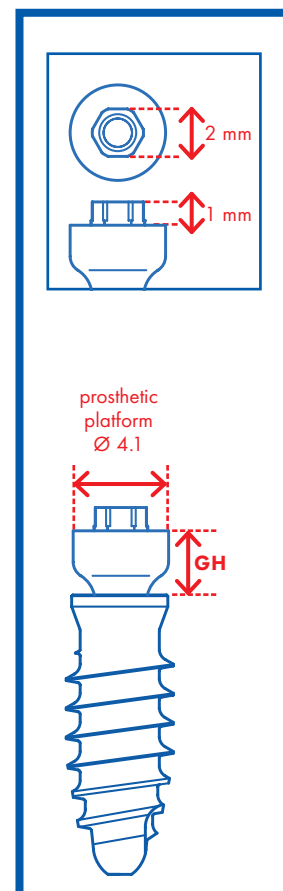

# EXACONNECT PLUS



## Necessary instruments:

- selection of the most appropriate ExaConnect Plus with the Abutment Gauges
- activation of the connection with the abutment seater with straight or offset titanium tip

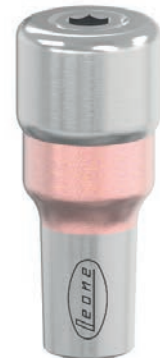

## Sterile package

- 1 ExaConnect with healing screw mounted on carrier



## ExaConnect Plus

1:1

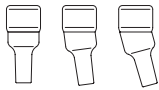
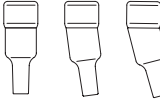
				
Ø connection (mm)	2.2	2.2	2.2	
GH (mm)	1.5	3	5	
REF	straight 7.5° angled 15° angled	<b>126-2221-01</b> <b>126-2221-07</b> <b>126-2221-15</b>	<b>126-2223-01</b> <b>126-2223-07</b> <b>126-2223-15</b>	<b>126-2225-01</b> <b>126-2225-07</b> <b>126-2225-15</b>

## ExaConnect Plus

1:1

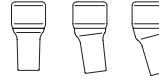
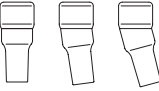
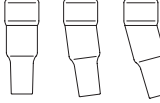
				
Ø connection (mm)	3.0	3.0	3.0	
GH (mm)	1.5	3	5	
REF	straight 7.5° angled 15° angled	<b>126-3021-01</b> <b>126-3021-07</b> <b>126-3021-15</b>	<b>126-3023-01</b> <b>126-3023-07</b> <b>126-3023-15</b>	<b>126-3025-01</b> <b>126-3025-07</b> <b>126-3025-15</b>

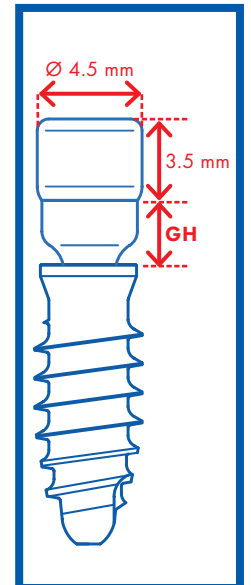

## HEALING SCREW FOR EXACONNECT

- made of medical grade 5 titanium
- for soft tissue conditioning with the ExaConnect
- autoclavable

**Pack of 1**

**Necessary instruments:**

short screw adapter with the prosthetic hand screwdriver

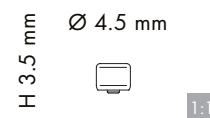

REF **126-2230-00**

## REPOSITIONABLE TRANSFER FOR EXACONNECT

- made of stainless steel
- to take an impression of the ExaConnect connected to the implant
- for closed tray technique
- autoclavable

**Necessary instruments:**

short screw adapter with the prosthetic hand screwdriver

**Pack content:**

- 1 repositionable transfer
- 1 screw for repositionable transfer

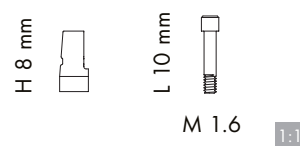

REF **144-2610-00**

## PICK-UP TRANSFER FOR EXACONNECT

- made of stainless steel
- to take an impression of the ExaConnect connected to the implant
- for open tray technique
- autoclavable

**Necessary instruments:**

short screw adapter with the prosthetic hand screwdriver

**Pack content:**

- 1 Pick-Up transfer
- 1 Pick-Up screw

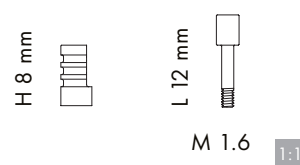

REF **144-2608-01**

## EXACONNECT ANALOG

- made of stainless steel
- to replicate the position of the ExaConnect in the dental cast

**Pack of 1**

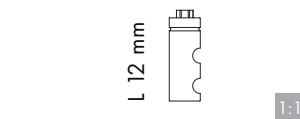

REF **146-2612-00**

## TI-BASE ABUTMENT FOR EXACONNECT

- made of medical grade 2 titanium
- for definitive restoration
- for the fabrication of a screw-retained crown with CAD-CAM technology or traditional method
- yellow anodized to camouflage the metal under translucent ceramic crowns
- autoclavable

### Pack content:

- 1 yellow anodized abutment
- 1 yellow anodized connecting screw



REF **121-2605-51**

## LAB AND SCAN TI-BASE FOR EXACONNECT

- made of stainless steel
- for digital impression taking and try-in on ExaConnect and ExaConnect analog
- not suitable for restoration
- autoclavable

### Pack content:

- 1 Lab and Scan Ti-Base
- 1 connecting screw



REF **141-2605-51**

## SCAN BODY INCLINED PLANE

- made of plastic material
- to take a digital impression of the ExaConnect in the mouth or to digitize the dental cast in the laboratory
- for use with Lab and Scan Ti-Base for ExaConnect
- autoclavable

**Pack of 5, white**



REF **141-0000-35**

## SCAN BODIES PIRAMID

- made of plastic material
- to take a digital impression of the ExaConnect in the mouth or to digitize the dental cast in the laboratory
- for use with Lab and Scan Ti-Base for ExaConnect
- autoclavable

**Pack of 10 (5 white and 5 grey)**



REF **141-0000-51**

## BURN-OUT COPING FOR TI-BASE FOR EXACONNECT

- made of burn-out plastic material
- to fabricate a patient-customized screw-retained crown with conventional method
- for use with Lab and Scan Ti-Base for ExaConnect

**Pack of 4**

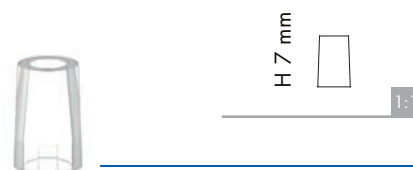

REF **121-0207-26**

## TEMPORARY ABUTMENT FOR EXACONNECT

- made of PEEK
- to fabricate a provisional screw-retained crown
- for temporary use only, max. 180 days
- radiolucent
- autoclavable

**Pack content:**

- 1 abutment
- 1 yellow anodized connecting screw



REF **161-2610-00**

## MULTIFUNCTIONAL SCREW FOR EXACONNECT

- made of medical grade 5 titanium
- to facilitate orientation and parallelization of the ExaConnect
- to create an adequate sized channel for the connecting screw when modelling the framework in the laboratory
- yellow anodized
- autoclavable

**Pack of 2**

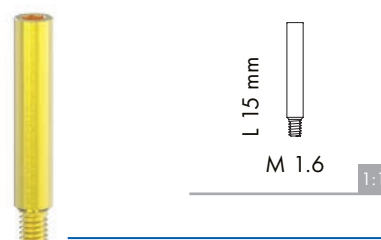

REF **126-0215-06**

## CONNECTING SCREW FOR EXACONNECT

- made of medical grade 5 titanium
- to fix the crown to the ExaConnect
- yellow anodized
- autoclavable

**Pack of 1**

**Necessary instruments:**

- screw adapter, short or long
- with the prosthetic hand screwdriver and
- with the prosthetic torque wrench (for the final tightening)



REF **126-0201-00**

**XCN<sup>®</sup> IMPLANT SYSTEM**

---

Multi-Unit Abutments (MUA)  
FOR SCREW-RETAINED  
PROSTHESIS  
AND ACCESSORIES

## MUA (Multi-Unit Abutment)

---

### Ideal for

---

- screw-retained bridges
- bar-retained overdentures
- immediate loading (e.g. All-on-four)
- transgingival healing  
(with the corresponding healing screw)



### Features

---

- made of medical grade 5 titanium
- tapered top for the connection of a multi-unit screw-retained restoration
- **MUA:** autoclavable  
delivered mounted on a multifunctional screw for easy positioning and orientation in the dental cast
- **MUA Plus:** sterile  
delivered mounted on a carrier for easy positioning and orientation in the implant

### Broad abutment assortment

---

The Leone MUA assortment is the broadest on the market with angulations of: 0°, 7,5°, 15°, 25° and 35° and various gingival heights.

Abutment Gauges are available to facilitate the selection of the most appropriate abutment.

### Prosthetic versatility

---

The MUA has a range of accessories for various fabrication techniques of screw-retained prosthesis:

- **CAD-CAM interfaces** available in the most popular software like 3Shape Dental System, Exocad DentalCAD and DWOS Dental Wings\* for digital fabrication of screw-retained bars and bridges;
- **titanium cylinders**, with retention grooves and two opposite plain faces for bonding techniques;
- **titanium cylinders with increased wall thickness** with smooth surface and specific titanium wires ideal for welding techniques
- **burn-out cylinders, standard and high** for casting techniques.

\*3Shape Dental System is trademarks of 3Shape, Exocad is a registered trademark of Exocad GmbH, DWOS and Dental Wings are registered trademarks of Dental Wings.



## Prosthetic flexibility

The MUA fits to any clinical situation thanks to the XCN® 360° connection. The movable hexagon allows for 360° positioning on the dental cast and facilitates the achievement of parallelism. The permanent connection of the hexagon in the selected position guides the clinician in the accurate positioning in the mouth.

## Quick and reliable procedure

With the Leone system there is only one screw to deal with as the connection between abutment and implant is accomplished with the screwless self-locking Morse taper connection. The prosthetic screw is extremely strong with a diameter of 2 mm (M2).

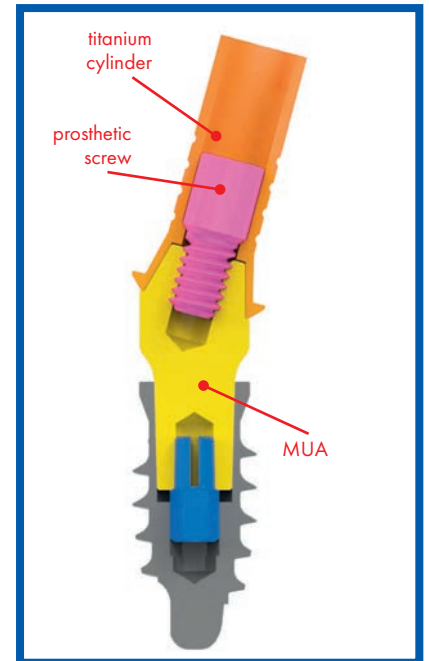

## MUA PLUS - sterile

The MUA Plus is designed for insertion immediately after implant placement. It is delivered mounted on a carrier that facilitates its positioning and orientation in the implant. The abutment has no index (hexagon) and can rotate freely. The immediate retention of the Morse taper avoids any unwanted displacement of the abutment prior to definitive fixing in the implant.

The system includes specific accessories designed for the passive seating of structures during immediate loading procedures, such as titanium cylinders and specific multifunctional screws (ideal for intraoral bonding techniques) or titanium cylinders with increased wall thickness and titanium wires for intraoral welding techniques.

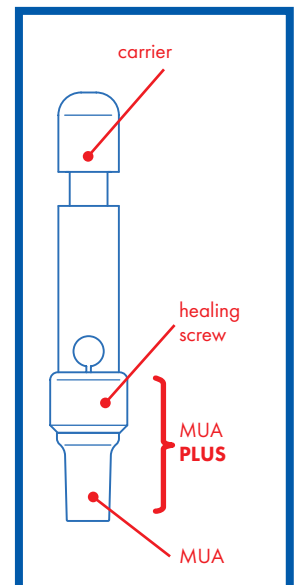

## MUA





### Necessary instruments

- selection of the most appropriate MUA with the Abutment Gauges
- activation of the connection with the abutment seater with straight or offset PEEK tip

### Package

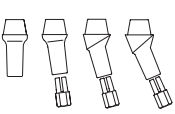
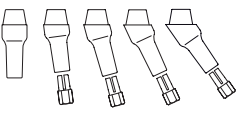
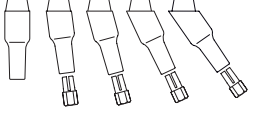

- 1 abutment mounted on multifunctional screw
- 1 hexagon (for the angled abutments only)

### MUA

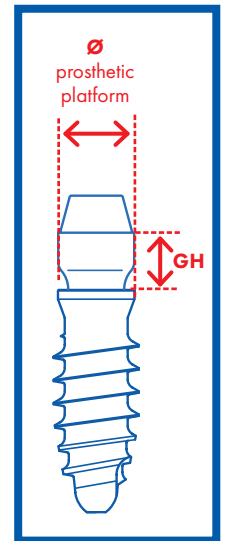
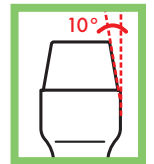
					1:1
Ø connection (mm)	2.2	2.2	2.2	2.2	
Ø prosthetic platform (mm)	3.3	3.3	3.3	3.3	
GH (mm)	1.5	3	5	7	
straight	<b>126-3311-01</b>	<b>126-3313-01</b>	<b>126-3315-01</b>	<b>126-3317-01</b>	
75° angled	<b>126-3311-07</b>	<b>126-3313-07</b>	<b>126-3315-07</b>		
REF 15° angled	<b>126-3311-15</b>	<b>126-3313-15</b>	<b>126-3315-15</b>		
25° angled	<b>126-3311-25</b>	<b>126-3313-25</b>	<b>126-3315-25</b>		
35° angled		<b>126-3313-35</b>	<b>126-3315-35</b>		

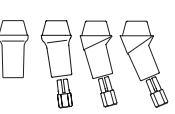
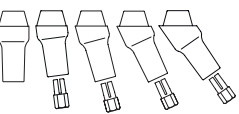
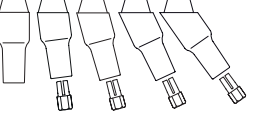

### MUA

					1:1
Ø connection (mm)	3.0	3.0	3.0	3.0	
Ø prosthetic platform (mm)	4.1	4.1	4.1	4.1	
GH (mm)	1.5	3	5	7	
straight	<b>126-4111-01</b>	<b>126-4113-01</b>	<b>126-4115-01</b>	<b>126-4117-01</b>	
75° angled	<b>126-4111-07</b>	<b>126-4113-07</b>	<b>126-4115-07</b>		
REF 15° angled	<b>126-4111-15</b>	<b>126-4113-15</b>	<b>126-4115-15</b>		
25° angled	<b>126-4111-25</b>	<b>126-4113-25</b>	<b>126-4115-25</b>		
35° angled		<b>126-4113-35</b>	<b>126-4115-35</b>		

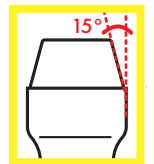

# MUA PLUS



## Necessary instruments

- selection of the most appropriate MUA Plus with the Abutment Gauges
- activation of the connection with the abutment seater with straight or offset titanium tip

## Sterile package

- 1 abutment with healing screw mounted on carrier



MUA Plus

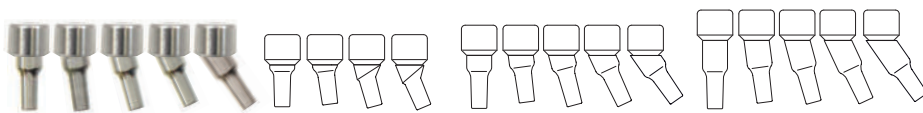
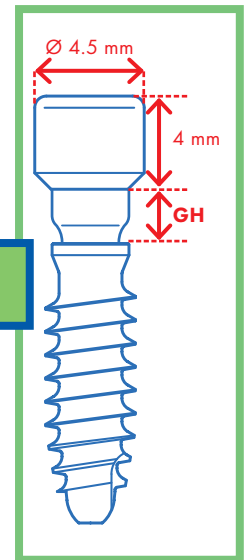

Ø connection (mm)	2.2	2.2	2.2
Ø prosthetic platform (mm)	3.3	3.3	3.3
GH (mm)	1.5	3	5

straight	<b>126-3321-01</b>	<b>126-3323-01</b>	<b>126-3325-01</b>
7.5° angled	<b>126-3321-07</b>	<b>126-3323-07</b>	<b>126-3325-07</b>
REF 15° angled	<b>126-3321-15</b>	<b>126-3323-15</b>	<b>126-3325-15</b>
25° angled	<b>126-3321-25</b>	<b>126-3323-25</b>	<b>126-3325-25</b>
35° angled		<b>126-3323-35</b>	<b>126-3325-35</b>

MUA Plus

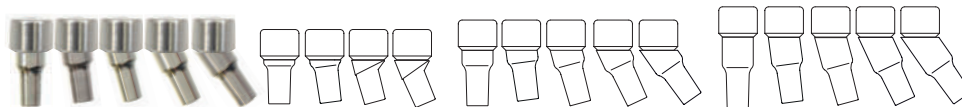
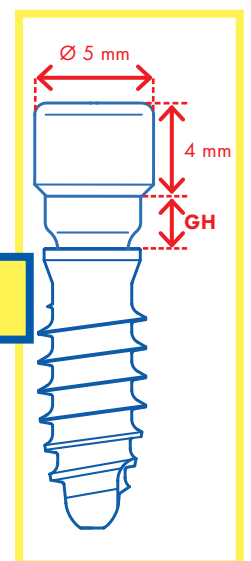

Ø connection (mm)	3.0	3.0	3.0
Ø prosthetic platform (mm)	4.1	4.1	4.1
GH (mm)	1.5	3	5

straight	<b>126-4121-01</b>	<b>126-4123-01</b>	<b>126-4125-01</b>
7.5° angled	<b>126-4121-07</b>	<b>126-4123-07</b>	<b>126-4125-07</b>
REF 15° angled	<b>126-4121-15</b>	<b>126-4123-15</b>	<b>126-4125-15</b>
25° angled	<b>126-4121-25</b>	<b>126-4123-25</b>	<b>126-4125-25</b>
35° angled		<b>126-4123-35</b>	<b>126-4125-35</b>

## HEALING SCREWS FOR MUA

- made of medical grade 5 titanium
- for soft tissue conditioning with MUA
- colour-coded
- autoclavable

**Pack of 1**

**Necessary instruments:**

short screw adapter with the prosthetic hand screwdriver

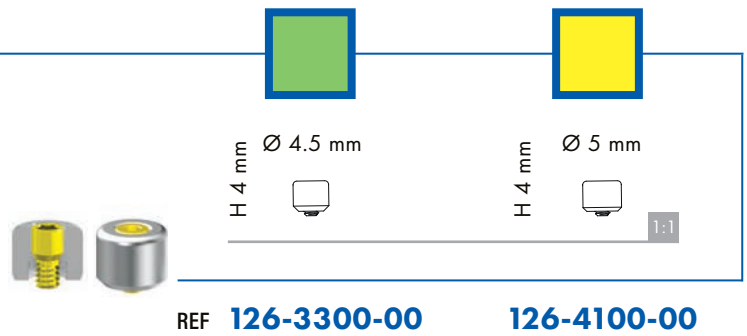

## REPOSITIONABLE TRANSFER FOR MUA

- made of stainless steel
- to take an impression of the MUA connected to the implant
- for closed tray technique
- colour-coded
- autoclavable

**Pack of 1**

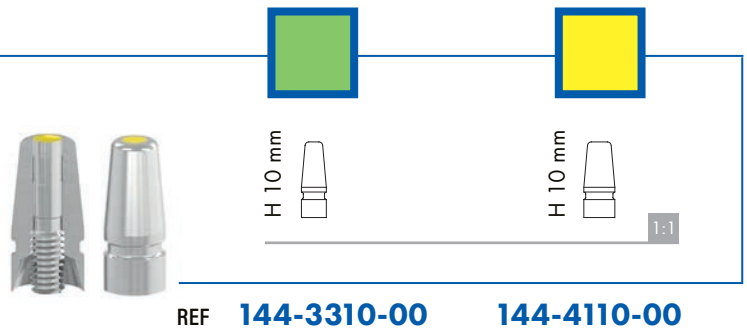

## PICK-UP TRANSFER FOR MUA

- made of stainless steel
- to take an impression of the MUA connected to the implant
- for open tray technique
- colour-coded
- autoclavable

**Pack content:**

- 1 Pick-Up transfer
- 1 Pick-Up screw

**Necessary instruments:**

short screw adapter with the prosthetic hand screwdriver

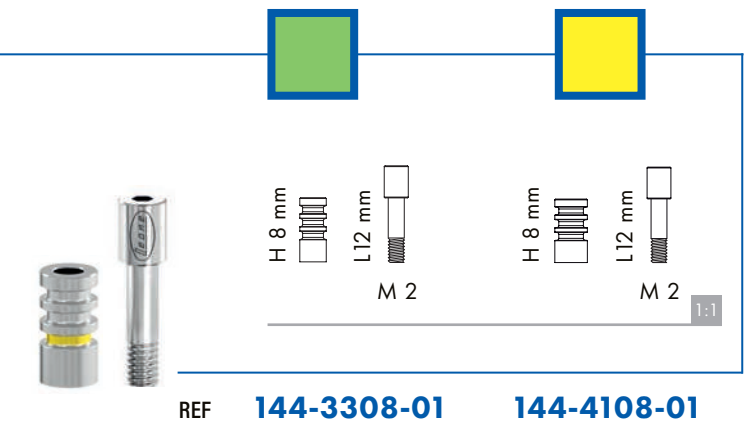

## MUA ANALOGS

- made of stainless steel
- to replicate the position of the MUA in the dental cast
- colour-coded

**Pack of 1**

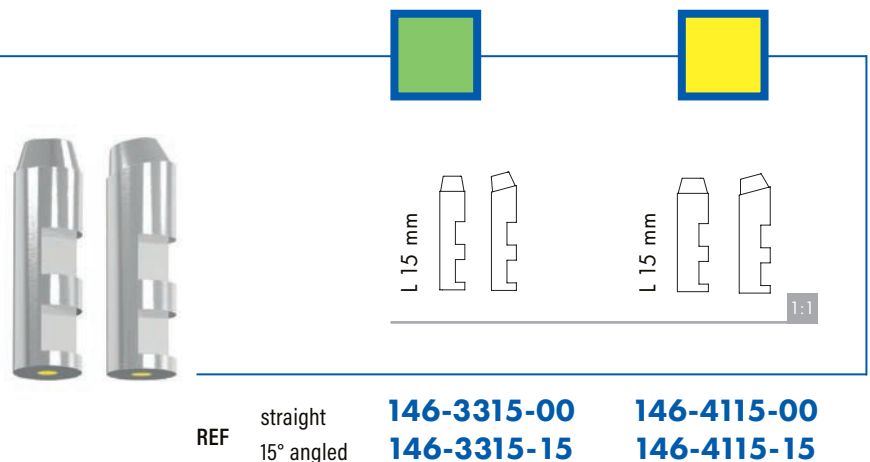

## SCAN BODY FOR MUA

- made of PEEK
- to take a digital impression of the MUA in the mouth or to digitize the dental cast in the laboratory
- autoclavable

**Pack of 5**



REF **141-0026-35**

## DIGITAL ANALOGS FOR MUA

- made of stainless steel
- to be positioned inside a rapid prototyping dental cast originated from an intraoral digital impression
- colour-coded

**Pack content:**

- 1 analog
- 1 multifunctional screw for the positioning in the dental cast
- 2 pins for the stabilization within the cast

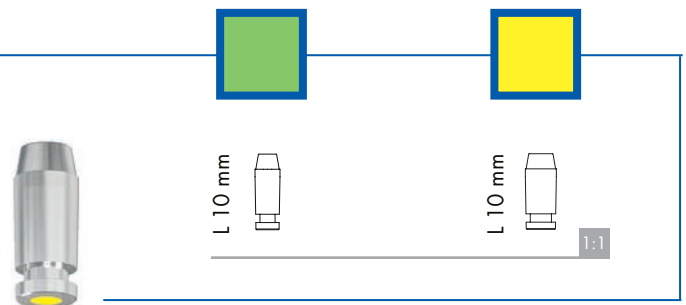

REF **142-2210-54**

**142-3010-54**

## CAD-CAM INTERFACES FOR MUA

- made of medical grade 5 titanium
- to fix a CAD-CAM fabricated prosthesis to the MUA in case of bonding techniques (e.g. PEEK or zirconia structures)
- colour-coded
- autoclavable

**Pack content:**

- 2 CAD-CAM interfaces
- 2 standard connecting screws, blue anodized

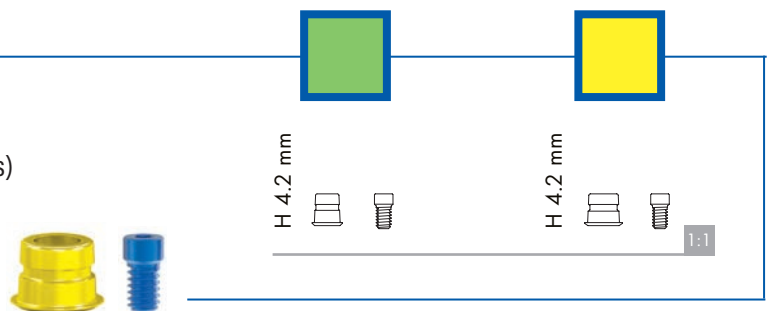

REF **126-0304-22**

**126-0404-30**

## BONDING CYLINDERS FOR MUA

- made of medical grade 5 titanium
- to fix the prosthesis to the MUA
- supplied with cylindrical burn-out coping for bonding techniques
- 0.4 mm wall thickness
- colour-coded
- autoclavable

**Pack content:**

- 2 cylinders
- 2 burn-out copings for bonding cylinders
- 2 standard connecting screws, blue anodized
- 2 high head connecting screws, blue anodized

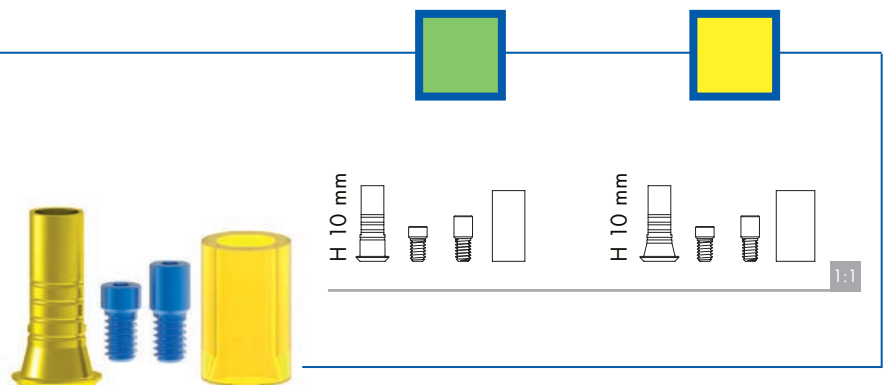

REF **126-0410-22**

**126-0410-30**

## STANDARD BURN-OUT CYLINDERS FOR MUA

- made of burn-out plastic material
- colour-coded

### Pack content:

- 4 cylinders
- 4 standard connecting screws, blue anodized

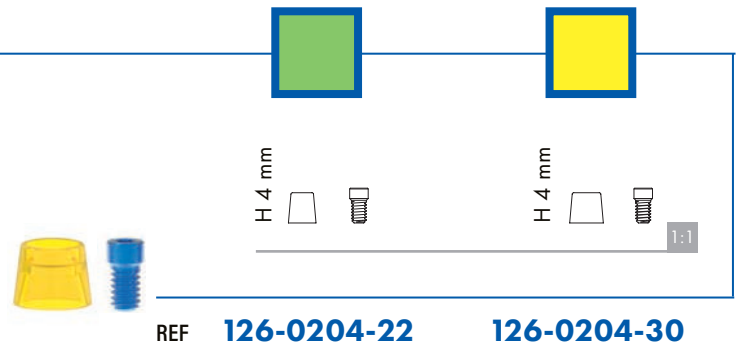

## HIGH BURN-OUT CYLINDERS FOR MUA

- made of burn-out plastic material
- colour-coded

### Pack content:

- 4 cylinders
- 4 high head connecting screws, blue anodized

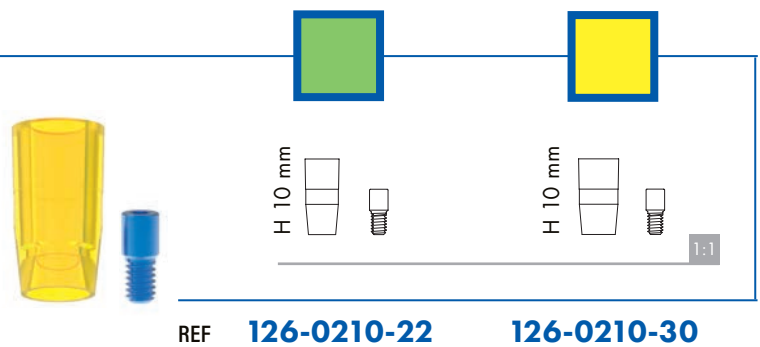

## WELDING CYLINDERS FOR MUA

- made of medical grade 5 titanium
- to fix the prosthesis to the MUA
- wall thickness 0.8 mm
- colour-coded
- autoclavable

### Pack content:

- 2 cylinders
- 2 standard connecting screws, blue anodized
- 2 high head connecting screws, blue anodized

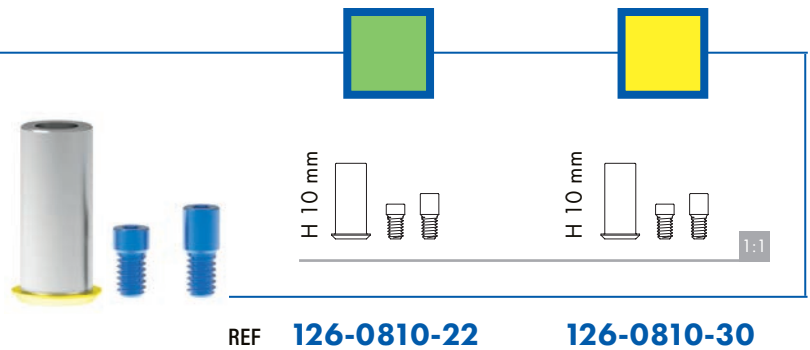

## TITANIUM WIRES FOR WELDING

- made of medical grade 2 titanium
- for intra or extra-oral welding techniques
- Ø 1.5 mm: for distances among abutments ≤ 8 mm
- Ø 2 mm: for distances among abutments > 8 mm
- autoclavable

### Pack of 5

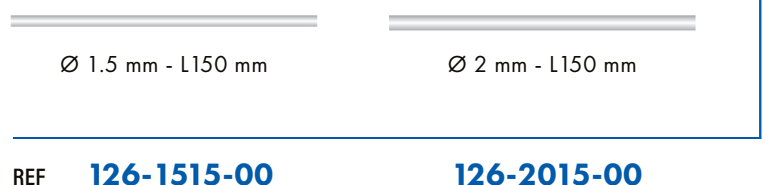

## MULTIFUNCTIONAL SCREW

- made of medical grade 5 titanium
- to position the MUA onto the implant
- to facilitate orientation and parallelization of the abutments
- to close the channels of the titanium cylinders during the fixation of the prosthesis
- to create an adequate sized channel for the connecting screw when modelling the framework in the laboratory
- blue anodized
- autoclavable

**Pack of 2**

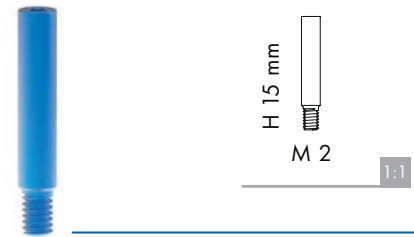

REF **126-0115-06**

## CONNECTING SCREWS FOR MUA

- made of medical grade 5 titanium
- to fix the prosthesis to the MUA
- blue anodized
- autoclavable

**Pack of 1**

### Necessary instruments:

screw adapter, short or long:

- with the prosthetic hand screwdriver and
- with the prosthetic torque wrench (for the final tightening)

**standard**

**high head**

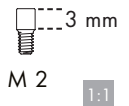
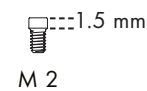

REF

**126-0101-00**

**126-0101-06**

### NOTE:

- connecting screws and MUA cylinders have been improved.
- All new accessories **are compatible** with the abutments for screw-retained prosthesis listed in the previous catalogue.
- New connecting screws (**blue anodized**) are **NOT compatible** with the titanium and burn-out copings of the previous catalogue.
- Connecting screws of the previous catalogue (**not anodized**) are **NOT compatible** with new MUA cylinders.
- For previously restored cases the connecting screws and the titanium copings listed in the previous catalogue remain available.







**XCN<sup>®</sup> IMPLANT SYSTEM**

---

CONOMETRIC-RETAINED  
PROSTHESIS  
AND ACCESSORIES

## XCN® CONOMETRIC-RETAINED PROSTHESIS easy, precise and safe

Based on the long experience and the success with the self-locking Morse taper implant-abutment connection, new prosthetic components have been developed that provide a conometric friction retention between the abutment and prosthesis. By screwing the Conic Adapter onto the MUA, the abutment gets a tapered top with a half-angle of 5° allowing for prosthesis retention by preformed caps that feature an internal connection of the same taper angle.



### Ideal for

- fixed bridges
- removable prostheses
- intraoral welding techniques

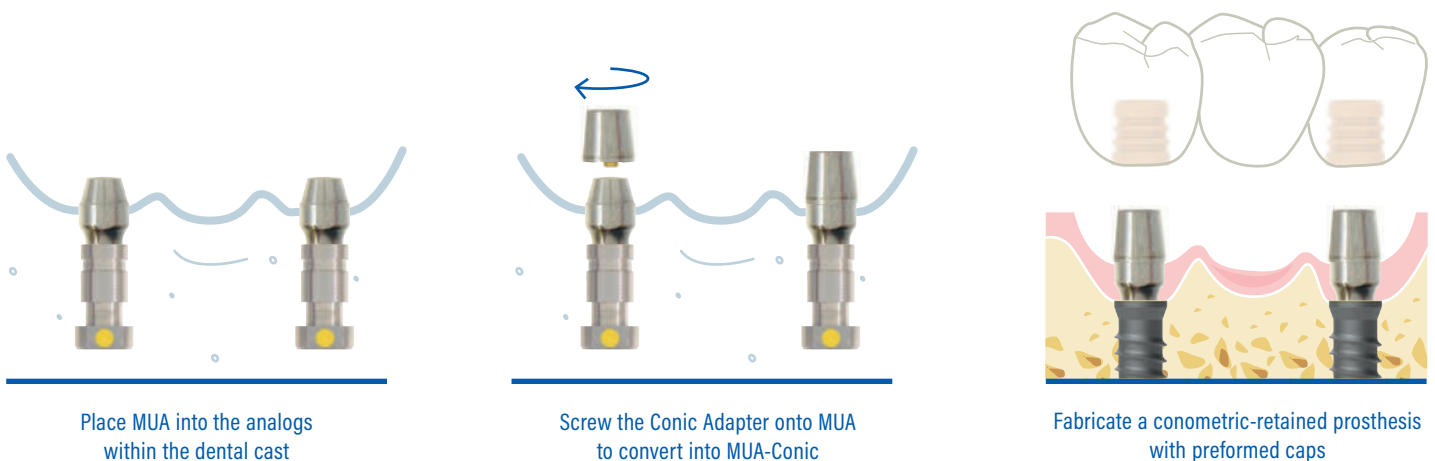

The pictures and illustrations in this brochure are for information purposes only and they are not intended to replace the methods or procedures for diagnosis and treatment planning of the Dental surgeon, Dentist and Dental Technician regarding the needs of each patient. Leone Spa disclaims any liability or any other obligation expressed or implied in this brochure. 

## PREFORMED CONOMETRIC CAPS

There are three different types of caps for three distinct uses: **FIXED** caps made of PEEK for fixed prostheses, **MOBILE** caps made of PEEK for removable prostheses and **WELDING** titanium caps for intraoral welding techniques.

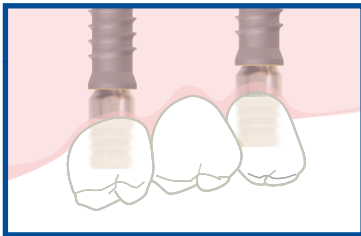
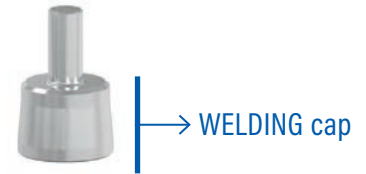

### FIXED cap

#### **Fixed bridges - without cement and without screws**

The conometric connection between the **FIXED** cap embedded within the prosthesis and the abutment allows for the fabrication of fixed multi-unit restorations.

Thanks to the use of conometric friction retention instead of cement or screws, the clinician can easily remove the prosthesis for hygiene in the dental office.

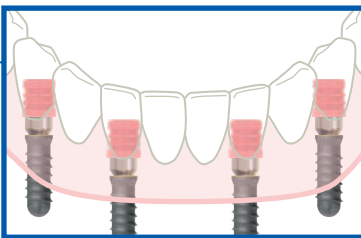

### MOBILE cap

#### **Removable prostheses**

The conometric connection between the **MOBILE** cap embedded within the prosthesis and the abutment allows for the fabrication of removable prostheses which are easily removed by the patient for daily hygiene.

An innovative alternative to overdentures on ball head abutments, that gives the patient the comfort of a fixed prosthesis.

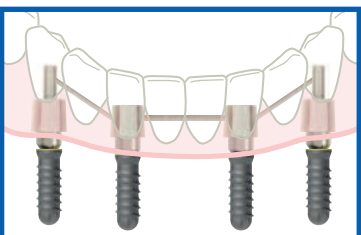

### WELDING cap

#### **Intra-oral welding technique**

The **WELDING** caps placed on the abutments can be splinted together with a titanium wire through an intra-oral welding process. This allows for rigid splinting of the implants, accurate impression taking and a perfect passivation of the structure; this technique is especially useful in cases of immediate loading.

The connection of the **WELDING** caps guarantees a secure and fixed retention but leaves the clinician the ability to remove the denture easily at any time.

## CONIC ADAPTERS FOR MUA

- made of medical grade 5 titanium
- tapered top with a half-angle of 5°
- supplied with specific colour-coded screw for attachment to the MUA
- autoclavable

**Pack of 2**

**Necessary instruments:** short screw adapter with the prosthetic hand screwdriver and with torque instruments for final tightening onto the MUA  
- activation of the locking-taper connection of the abutment with the abutment seater with straight or offset PEEK tip

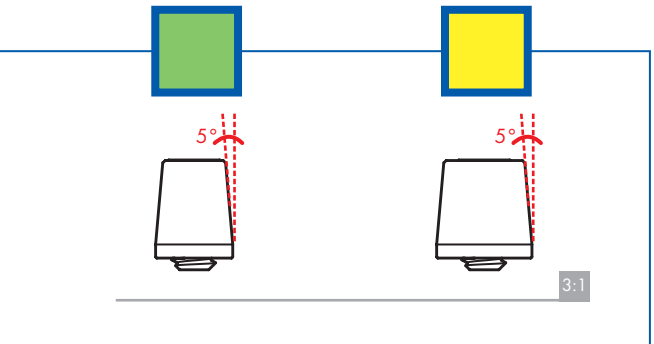

REF **123-4328-22**

**123-4336-30**

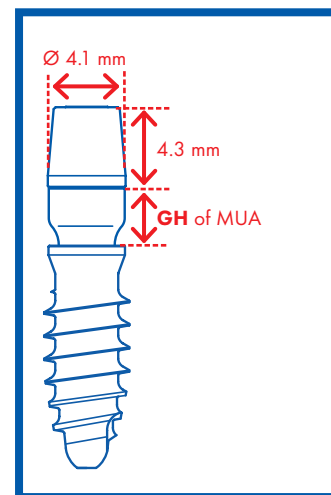
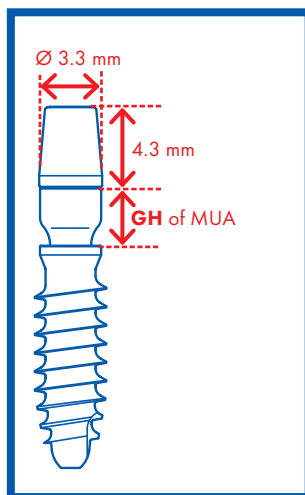

## Prosthetic flexibility

The use of the MUA together with the Conic adapter makes the conometric XCN® restoration extremely flexible. They fit to any clinical situation, thanks to the wide range of angulations (0°, 7.5°, 15°, 25°, 35°) in different gingival heights (1.5-3-5-7 mm) and the XCN® 360° connection. Furthermore it makes possible to convert from a conometric-retained to a screw-retained restoration and vice versa, without having to remove the MUA. For MUA and MUA Plus' catalogue codes, see pages 66 and 67.

## FIXED CAPS *patented*

- made of PEEK
- for the fabrication of fixed bridges
- wall thickness 0.4 mm
- autoclavable

**Pack of 2**

**Necessary instrument:**

activation of the connection with the abutment seater with straight or offset PEEK tip

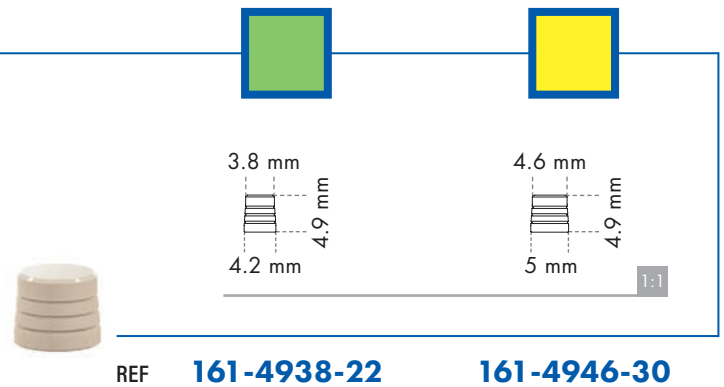

## MOBILE CAPS *patented*

- made of PEEK
- for the fabrication of removable prostheses
- wall thickness 0.6 mm
- autoclavable

**Pack of 2**

**Necessary instrument:**

activation of the connection with the abutment seater with straight or offset PEEK tip

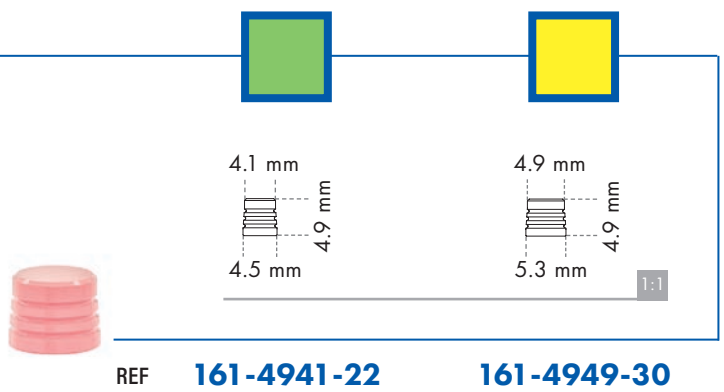

## WELDING CAPS

- made of medical grade 5 titanium
- for intraoral welding techniques
- wall thickness 0.7 mm
- autoclavable

**Pack of 2**

**Necessary instrument:**

activation of the connection with the abutment seater with straight or offset PEEK tip

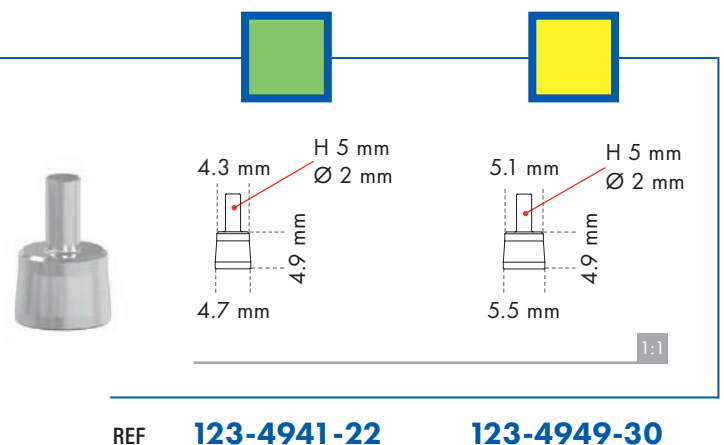

## TITANIUM WIRES FOR WELDING

- made of medical grade 2 titanium
- for intra or extra-oral welding techniques
- Ø 1.5 mm: for distances among abutments ≤ 8 mm
- Ø 2 mm: for distances among abutments > 8 mm
- autoclavable

**Pack of 5**

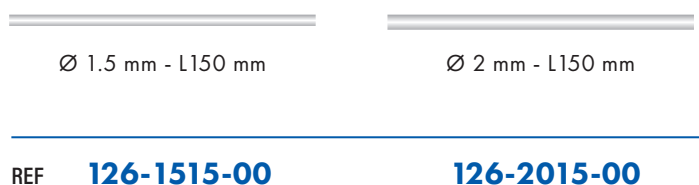



**XCN<sup>®</sup> IMPLANT SYSTEM**

---

ABUTMENTS FOR  
ATTACHMENT-RETAINED  
PROSTHESIS  
AND ACCESSORIES

## BALL HEAD ABUTMENTS



### Ideal for

- overdentures

### Features

- made of medical grade 5 titanium
- ball-shaped top for the anchorage of a removable prosthesis with specific housings
- ball head  $\varnothing$  2.15 mm
- autoclavable

### Wear resistant

The ball head of the abutments is titanium nitride (TiN) coated to increase its wear resistance.

### Easy parallelization

The Leone ball head abutments are available in straight and 15° angled version, with three different gingival heights.

The achievement of parallelism is also facilitated by the XCN® 360° connection of the angled abutments.

The movable hexagon allows for 360° positioning on the dental cast and the permanent connection of the hexagon in the selected position guides the clinician in the accurate positioning in the mouth.



## Wide range of housings

According to the needs of the case it is possible to choose between different housing types:

- **titanium housings with insert**, pink anodized for better aesthetics, choose between three types of rigidity: soft (white), medium (orange), rigid (violet)
- **titanium housings with O-ring**
- **titanium micro housings with micro O-ring**

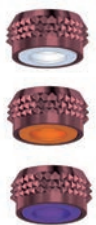

ANODIZED TITANIUM  
HOUSINGS with:  
- soft insert (white)  
- medium insert (orange)  
- rigid insert (violet)



TITANIUM  
HOUSINGS  
with O-ring



TITANIUM  
MICRO HOUSINGS  
with micro O-ring





## Necessary instruments:

- selection of the most appropriate ball head abutment with the Abutment Gauges
- activation of the connection with the abutment seater with straight or offset titanium tip





## Pack content:

- 1 abutment
- 1 hexagon (for the angled abutments only)
- 1 housing with O-ring
- 1 housing with orange insert
- 2 spacer rings for abutments

## Ball head abutments

		1:1			
					
Ø connection (mm)		2,2	2,2	2,2	
Ø prosthetic platform (mm)		3,3	3,3	3,3	
GH (mm)		1,5	3	5	
REF	straight	<b>123-3300-01</b>	<b>123-3300-03</b>	<b>123-3300-05</b>	
	15° angled	<b>123-3315-01</b>	<b>123-3315-03</b>	<b>123-3315-05</b>	

## Ball head abutments

		1:1			
					
Ø connection (mm)		3,0	3,0	3,0	
Ø prosthetic platform (mm)		4,1	4,1	4,1	
GH (mm)		1,5	3	5	
REF	straight	<b>123-4100-01</b>	<b>123-4100-03</b>	<b>123-4100-05</b>	
	15° angled	<b>123-4115-01</b>	<b>123-4115-03</b>	<b>123-4115-05</b>	

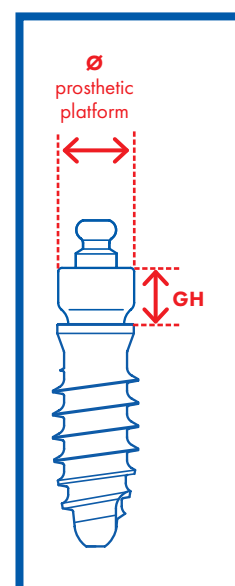

## HOUSING WITH **SOFT INSERT** white

- housing made of medical grade 5 titanium
- with pre-mounted soft white insert
- retention force 5 N
- cold sterilization

**Pack content:**

- 2 housings with insert
- 2 spacer rings for abutments

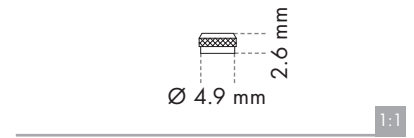

REF **123-0004-05**

## SOFT INSERT white

- made of elastomeric material
- refill for housing with insert
- cold sterilization

**Pack of 6**



2:1

REF **123-0001-05**

## HOUSING WITH **MEDIUM INSERT** orange

- housing made of medical grade 5 titanium
- with pre-mounted medium orange insert
- retention force 10 N
- cold sterilization

**Pack content:**

- 2 housings with insert
- 2 spacer rings for abutments

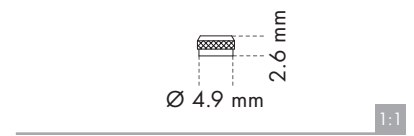

REF **123-0004-06**

## MEDIUM INSERT orange

- made of elastomeric material
- refill for housing with insert
- cold sterilization

**Pack of: 6**



2:1

REF **123-0001-06**

## HOUSING WITH **RIGID INSERT** violet

- housing made of medical grade 5 titanium
- with pre-mounted rigid violet insert
- retention force 15 N
- cold sterilization

**Pack content:**

- 2 housings with insert
- 2 spacer rings for abutments

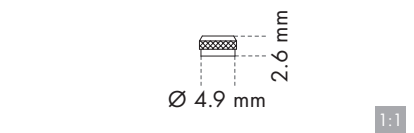

REF **123-0004-07**

## RIGID INSERT violet

- made of elastomeric material
- refill for housing with insert
- cold sterilization

**Pack of 6**



2:1

REF **123-0001-07**

## INSERT SEATING TOOL

- made of stainless steel
- used to place the insert inside its housing

**Pack of 1**



1:1

REF **156-1004-00**

## HOUSING WITH O-RING

- made of medical grade 5 titanium
- with pre-mounted O-ring
- retention force 10 N
- autoclavable

**Pack content:**

- 1 housing with O-ring
- 1 spacer ring for abutments

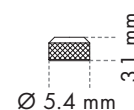

1:1

REF **123-0002-00**

## O-RING

- made of elastomeric material
- refill for housing with O-ring
- autoclavable

**Pack of 10**



2:1

REF **123-0001-00**

## MICRO HOUSING WITH MICRO O-RING

- made of medical grade 5 titanium
- with pre-mounted micro O-ring
- retention force 10 N
- autoclavable

**Pack content:**

- 1 micro housing with micro O-ring
- 1 spacer ring for abutments (grey)
- 1 spacer ring for monoimplants (white)

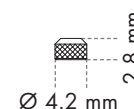

1:1

REF **123-0003-00**

## MICRO O-RING

- made of elastomeric material
- refill for micro housing with micro O-ring
- autoclavable

**Pack of 10**



2:1

REF **123-0001-01**

**XCN<sup>®</sup> IMPLANT SYSTEM**

---

PROSTHETIC AND  
LABORATORY INSTRUMENTS

## ABUTMENT GAUGES

- made of stainless steel
- one instrument for two functions: measurement of soft tissue thickness and selection of the most appropriate abutment angulation
- for universal use, suitable for all abutment types and for both connection diameters, green and yellow
- the apical split cylinder ensures excellent retention in the internal hexagon of the implant/analog allowing for free rotation to 360°
- ideal for immediate loading procedures
- with a hole for the placement of a safety leash
- autoclavable for safe use in the dental office and in the laboratory

**Pack of 1**

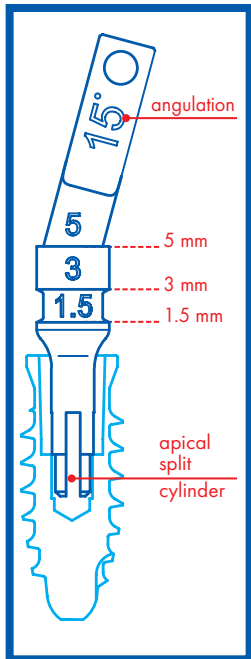

straight



7.5° angled



15° angled



25° angled



35° angled

2:1

REF **141-0000-00** **141-0075-00** **141-0015-00** **141-0025-00** **141-0035-00**

## ORGANIZER FOR ABUTMENT GAUGES

- made of PPSU plastic material
- entirely autoclavable

**Pack content:**

- 1 abutment Gauge 0°
- 1 abutment Gauge 7.5°
- 1 abutment Gauge 15°
- 1 abutment Gauge 25°
- 1 abutment Gauge 35°



REF **141-0001-03**

## ABUTMENT SEATER

- made of stainless steel
- provides the right percussive force to seat the healing cap and the abutment into the implant
- to activate the connection between the preformed conometric cap and the MUA-Conic
- interchangeable seating tips
- autoclavable

### ABUTMENT SEATER WITH STRAIGHT TIPS



REF **156-1008-03**

**Pack content:**

- 1 abutment seater
- 1 straight titanium tip
- 1 straight PEEK tip



1:1

### ABUTMENT SEATER WITH OFFSET TIPS



REF **156-1008-04**

**Pack content:**

- 1 abutment seater
- 1 offset titanium tip
- 1 offset PEEK tip



1:1

## SEATING TIPS

- made of medical grade 5 titanium and PEEK
- to be screwed onto the abutment seater
- **straight tips:** for the anterior region
- **offset tips:** for the posterior region
- **PEEK tips:** for ceramic crowns, MUA, ExaConnect, MUA-Conic and preformed conometric caps
- **flat tip:** for angled abutments for cement-retained prosthesis
- autoclavable

**Pack of 1**

straight titanium tip

REF **156-1008-01**



straight PEEK tip

REF **156-1008-08**



offset titanium tip

REF **156-1008-02**



offset PEEK tip

REF **156-1008-09**



flat titanium tip

REF **156-1008-06**



## HEX HEAD EXTRACTOR FOR HEALING CAPS

- made of stainless steel
- to unlock the healing cap and thus permit its removal
- hexagon on both ends for easy use in all situations
- autoclavable

**Pack of 1**



1:1

REF **156-1006-00**

## WEINGART STYLE PLIERS

- made of stainless steel
- to firmly hold the abutment during try-in phases
- with rounded and ribbed tips for a safe grip of the abutment
- autoclavable

**Pack of 1**



1:1

REF **P2104-00**

## REMOVAL TOOL FOR ABUTMENTS

- made of stainless steel
- allows the application of the extraction force necessary to remove a definitively seated abutment from the implant
- **two models:** one for all abutments of the Standard prosthetic platform and one for all abutments of the Large prosthetic platform
- autoclavable

**Pack of 1**



1:1

REF **156-1022-01**

**standard**

REF **156-1022-02**

**large**

## SCREW ADAPTERS

- made of stainless steel
- for use with the prosthetic hand screwdriver, the prosthetic torque wrench and the lab torque screwdriver to tighten the connecting screws, the healing screws and the Conic adapter
- autoclavable

**Pack content:**

- 1 screw adapter
- 1 prosthetic hand screwdriver



1:1

REF **126-0003-00**

**126-0003-01**



## PROSTHETIC HAND SCREWDRIVER

- made of medical grade 5 titanium
- for use with the specific screw adapter to hand tighten the connecting screws, the healing screws and the Conic adapter
- with a hole for the placement of a safety leash
- autoclavable

**Pack of 1**



1:1

REF **156-1001-00**

## PROSTHETIC TORQUE WRENCH 25 Ncm

- made of stainless steel
- for use with the specific screw adapter to tighten the connecting screws and the Conic adapter with a torque of 25 Ncm
- two-way function: to screw in and unscrew
- can be disassembled for cleaning
- autoclavable

**Pack of 1**



1:1

REF **156-1014-26**

## TORQUE SCREWDRIVER 25 Ncm FOR LABORATORY

- made of stainless steel
- for use with the specific screw adapter to tighten the connecting screws and the Conic adapter with a torque of 25 Ncm
- two-way function: to screw in and unscrew
- do not disassemble for cleaning
- autoclavable

**Pack of 1**



1:1

REF **156-2006-00**

## HANDLE FOR ABUTMENTS

- made of medical grade 5 titanium
- for use during abutment preparation in the laboratory and in the dental office

**Pack of 1**



for abutment with  $\varnothing$  connection (mm)

2.2

1:1

REF **156-1007-33**



for abutment with  $\varnothing$  connection (mm)

3.0

1:1

REF **156-1007-41**

## SURGICAL DEMONSTRATION KIT

- to simulate the most relevant surgical and prosthetic phases of the XCN® implant system
- intended for demonstration use only

**Pack content:**

- 1 hemi-mandible
- 1 Classix implant Ø 4.1 mm (non-sterile) 10 mm long with cover cap and 5 cover cap refills connection 3.0
- 1 instrument for cover caps
- 1 Standard healing cap connection 3.0 GH 3 mm
- 1 Standard transfer connection 3.0
- 1 surgical hand screwdriver
- 1 hex head extractor
- 1 straight Standard Basic abutment connection 3.0



REF **106-0002-00**

## HEMI-MANDIBLE

- made of polyurethane
- presents a hole for the placement of a Classix implant Ø 4.1 mm, 10 mm long

**Pack of 1**



REF **106-0001-00**

## DEMONSTRATION JUMBO DENTAL IMPLANT

- made of aluminium
- scale 5:1 reproduction of straight Standard Basic abutment connection 3.0 and Classix implant Ø 4.1, 10 mm long
- use the rod included in the package for removal of the abutment from the Jumbo implant. A hole is present in the back of the implant for the rod.

**Pack of 1**

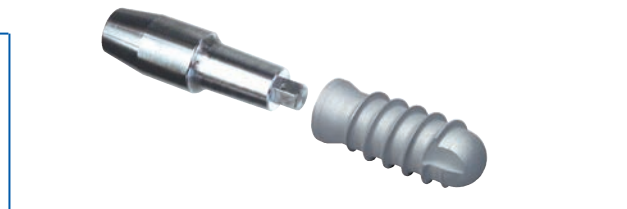

REF **106-0003-00**

## IMPLANT CARD

- supplied with each implant
- for unique identification of the placed implant
- for delivery to the patient
- contains essential information in case of dental care away from home or abroad



## PATIENT INFORMATION BROCHURE

- available on request

**Pack content:** 50 brochures in a carton box



## XCN<sup>®</sup> IMPLANT SYSTEM

---

# SURGICAL PROCEDURE



The pictures and illustrations in this brochure are for information purposes only and they are not intended to replace the methods or procedures for diagnosis and treatment planning of the Dental surgeon, Dentist and Dental Technician regarding the needs of each patient. Leone Spa disclaims any liability or any other obligation expressed or implied in this brochure.



## DISCLAIMER

---

**The Surgical Procedure and the use of the products of the XCN® Leone Implant System described in the following pages are intended for Professionals experienced in dental implant techniques.**

In case of lack of basic notions, we suggest to attend specific courses in order to reach a high level of knowledge and practice in the use of implants. The rules on the use of the products described below represent a group of standard instructions that must be adjusted to the single needs and to the particular situations that may occur according to the manual ability, to the experience and to the diagnosis made by the legally qualified medical operator.

It is not ascribed to the manufacturer the duty of monitoring the procedures of use of the product. A correct and appropriate use of the instruments and products related to the XCN® Leone Implant System shall completely be reverted to the clinician. The surgical procedure hereunder described is merely indicative as any single treatment case is assigned to the experience of the operator.

As every medical operator well knows, a correct procedure and a perfect manufacture of the prosthesis may sometimes be followed by not satisfactory results owing to particular situations not imputable to responsibility of the dental operator or the manufacturer.

## TREATMENT PLANNING

---

### Indications

SINGLE-TOOTH EDENTULISM, DISTAL EDENTULISM, MULTIPLE EDENTULISM, TOTAL EDENTULISM.

### Contraindications

For contraindications and side effects read the instructions for use enclosed in the package of each product and available in our web site [www.leone.it](http://www.leone.it) in the section **Services/Quality**

## PREOPERATORY EXAMS

---

Before starting the surgical intervention, the patients have to be subjected to a series of exams; single cases have to be evaluated in the opinion of the clinician.

### Anamnesis

It is the first approach to the patient and it represents a fundamental tool to recognize both risk factors and contraindications. Moreover, anamnesis allows for the evaluation of patient's expectations and priorities and of patient's degree of compliance and motivation. Anamnesis can help in evaluating the need for extra exams in addition to the routine ones (when the presence of pathologies that were not reported by the patient is suspected) and when particular situations drive to deem a complete medico-surgical exam may be necessary.

### Objective exam

It consists of:

- inspection of the periodontal tissues, of the oral mucosa and of the teeth along with an initial evaluation of the occlusal relationships (skeletal Class, characteristics of the opposing arch and related potential problems, type of occlusion, interarch distance), of the presence of parafunctions, of the degree of oral hygiene, of the aesthetic conditions, of the morphology of the edentulous crest and the space available for the replacement of the prosthesis.
- palpation of the soft tissues and implant sites for a preliminary evaluation of the bone morphology and thickness.
- a complete periodontal probing for the appraisal of the absence of both gingivitis and pockets
- Examination of the dental casts mounted in an articulator for a comparison with the information derived from previous exams, creation of a diagnostic set-up, and, if necessary, the implementation of a surgical template.

### Radiographic exams

PANORAMIC RADIOGRAPH: frequently, this radiograph allows an appraisal of the bone height and the relationships between implant site and adjacent structures, such as maxillary sinuses, nasal cavities, and mandibular canal. It is also possible to identify concavities and ossification defects due to previous tooth extractions.

**INTRAORAL RADIOGRAPH:** it is very helpful for the determination of the mesio-distal distance between the roots, and the apico-coronal availability of bone.

**LATERAL CEPHALOGRAM:** it is useful when interventions on the mandibular symphysis are planned.

**COMPUTERIZED TOMOGRAPHY CONE BEAM:** it is advisable to remind that previous radiographic exams provide two-dimensional images which do not give information on bone thickness. In order to obtain this useful information a Cone Beam computerized tomography (CBCT) is necessary: it provides three-dimensional images, thus allowing for an accurate evaluation of bone morphology and, sometimes, bone density.

### Instrumental or laboratory exams or medical advices

When necessary, in cases where a pathology is suspected on the basis of anamnesis or clinical records.

## IMPLANT SELECTION

---

The number and dimensions (diameter and length) of the implants to be used are determined by the following factors:

1. amount of bone available
  2. characteristics of the implant site
  3. masticatory load
  4. aesthetic results
  5. type of the prosthetic restoration
  6. type of the surgical procedure followed
- Further and particular single situations must be evaluated by the clinician.

Templates are available showing all XCN® Leone implants in actual dimensions, with dimensions increased by 10% and increased by 25%, to match possible distortions created by the X-ray unit used for the images (CBCT, panoramic radiograph, standard and digital cephalograms). To determine the distortion created by the X-ray unit you may use a sphere with a known diameter during X-ray exam. Superimpose the template to the radiograph in order to select the implant in relation to the quantity of bone available.

**Small diameter implants** (implant-abutment connection 2.2) are not recommended for the posterior region.

Small diameter implants, 8 mm long, are intended for use as a support in prosthesis composed of two or more implants of any diameter and length.

In case of single implants in molar position, **do not** fabricate restorations with mesial or distal cantilever extensions.

Do not place the **Max Stability implants** in thick cortical bone, equivalent to D1 bone density according to Misch Classification.<sup>[1]</sup>

The **2.9 Narrow implant** is suitable for cases with very narrow spaces. It is mainly indicated for narrow bony ridges and for limited interdental spaces in the anterior region, specifically for the upper lateral incisors and lower central and lateral incisors.

The use of the **6.5 Short implant** shall be restricted to cases with limited vertical bone availability.

It is not intended to be associated with sinus lift procedures, immediate loading or one-stage surgical technique.

**XCN® IMPLANTS ARE INTENDED FOR PLACEMENT AT THE LEVEL OF ALVEOLAR CREST OR BELOW THE LEVEL OF ALVEOLAR CREST UP TO 2 mm SUBCRESTALLY.**

**DO NOT PLACE LEONE IMPLANTS ABOVE THE LEVEL OF ALVEOLAR CREST.**

XCN® implant system is characterized by high mechanical strength, validated through fatigue testing performed according to ISO 14801 standard.<sup>[2]</sup>

The results are:

- Narrow implants Ø 2.9 mm: **220 N**;
- Classix implants Ø 3.3 mm and Max Stability implants Ø 3.75 mm: **240 N**;
- Classix implants Ø 4.1 mm, Max Stability implants Ø 4.5 mm, Short 6.5 implants, Classix implants Ø 4.8 mm: **392 N**.<sup>[3, 4]</sup>

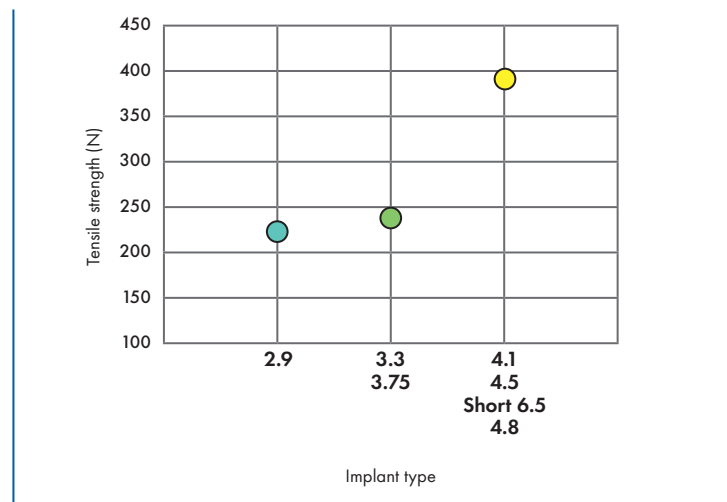

In the literature, in comparison, it is reported that the average force generated during mastication is 145 N with inclinations within 10°. <sup>[5, 6]</sup> It should also be stressed that very high masticatory forces <sup>[7, 8]</sup> can be generated due to many individual and prosthetic factors, such as crown height, cantilever and restoration type, which locally can exceed the strength limit of the implants, especially in case of single or unsplinted implants.

<sup>[1]</sup>Misch CE, Density of bone: effect on treatment plans, surgical approach, healing and progressive bone loading, Int J Oral Implant 1990; 6:23-31

<sup>[2]</sup>ISO 14801:2007 (E), Dentistry - Implants - Dynamic fatigue test for endosseous dental implants, International Organization for Standardization, Geneva, 2007

<sup>[3]</sup>Barlattani A, Sannino G, Mechanical evaluation of an implant-abutment self-locking taper connection: finite element analysis and experimental tests, Int J Oral Maxillofac Implants 2013;28:e17-e26

<sup>[4]</sup>Gervasi G, Impianto Leone Exacone 2,9 mm: caratteristiche e comportamento biomeccanico, Exacone News 25, 2017:18-22

<sup>[5]</sup>Carlsson GE, Haraldson T, Functional response, In: Branemark P-I, Zarb GA, Albrektsson T. Eds. Tissue integrated prostheses. Osseointegration in clinical dentistry. Chicago: Quintessence, 1985:155-63

<sup>[6]</sup>Graf H, Occlusal forces during function, In: Proceedings of Symposium on Occlusion: Research on Form and Function. University of Michigan School of Dentistry, Ann Arbor: Rowe NH (Ed.), 1975:90-111

<sup>[7]</sup>Craig RG, Restorative dental material, 6<sup>th</sup> ed. St. Louis, C.V. Mosby, 1980

<sup>[8]</sup>Peck CC, Biomechanics of occlusion - implications for oral rehabilitation, J Oral Rehabil 2016;43(3):205-214

**LEONE SURGICAL INSTRUMENTS ARE SUPPLIED NON-STERILE: CLEANING, DISINFECTION AND STERILIZATION AFTER REMOVAL FROM THE PACKAGE AND PRIOR TO EACH FURTHER USE ARE REQUIRED. CONSULT THE "Instructions for instrument sterilization" AVAILABLE FOR DOWNLOAD AT [www.leone.it](http://www.leone.it) IN THE SECTION Services/Quality.**

*The Surgical Procedure reported was conceived with the invaluable contribution of Dr. Leonardo Targetti, whom we thank sincerely.*

## Interactions between dental implant and medical imaging techniques

Titanium dental implants hardly cause pulling or heating sensation for the patient during Magnetic Resonance Imaging (MRI) and the artifacts on the bioimage are usually attributable to the implant-prosthetic device. For further details please refer to the document "Interactions between Leone orthodontic and implantology devices and medical imaging techniques" available for download at [www.leone.it](http://www.leone.it) in the section **Services/Quality**.

## XCN® IMPLANT PACKAGING

- double protection to preserve the sterility of the implant subjected to a certified gamma x-ray process
- 4 peel-off labels (2 with UDI Data Matrix) for:
  - the "Implant Card" to be delivered to the patient
  - the communication with the prosthetic team
  - the clinical case sheet of the patient
  - the inventory management
- with sterility indicator on the glass vial



## STERILE BARRIER: GLASS VIAL

Top lid with safety ring

the integrity of the top lid guarantees that the product is intact and sterile



indication of the diameter in the colour code of the implant

Sealing cap

ensures airtightness

Carrier

Implant

Inner holder

allows correct support of the implant and easy handling by the doctor

Cover cap



Glass vial

with **implant diameter, colour-coded** for immediate identification





## CARRIER FOR XCN® IMPLANTS

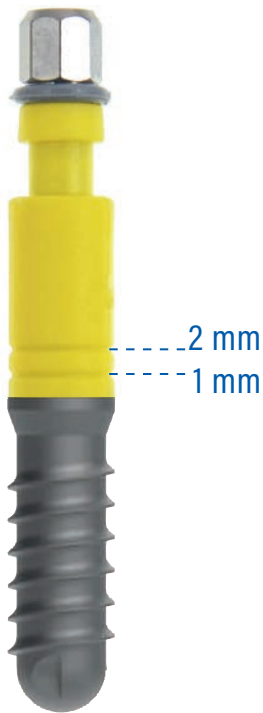

### Pre-mounted on each XCN® implant

- it maintains the implant suspended within the inner holder and prevents contact with the glass vial and the sterile field
- it enables the secure transfer of the implant into the mouth

### Colour-coded for instant identification

- the titanium core is covered by a biopolymer outer shell in the colour code of the implant

### With depth indicators

- at 1 and 2 mm for better visibility when inserting the implant below the level of alveolar crest

### With torque limiting device

- the torque limiting device makes the carrier break above the connection with the implant at 60 Ncm and then permits the removal of the carrier

### Easy removal

- it is removed together with the insertion device after implant placement

### Suitable as paralleling pin

- it is possible to place the carrier again on the implant to check the parallelism with natural teeth and/or adjacent implant sites

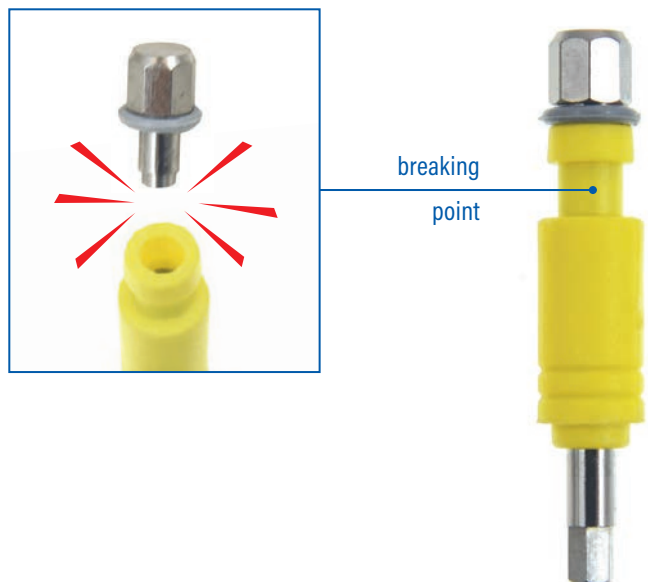



## REMOVAL OF XCN® IMPLANT FROM THE GLASS VIAL

- open the glass vial's top lid and extract the inner holder with the implant and cover cap on a sterile pad



- connect the handpiece adapter to the carrier of the implant and remove the implant from the holder

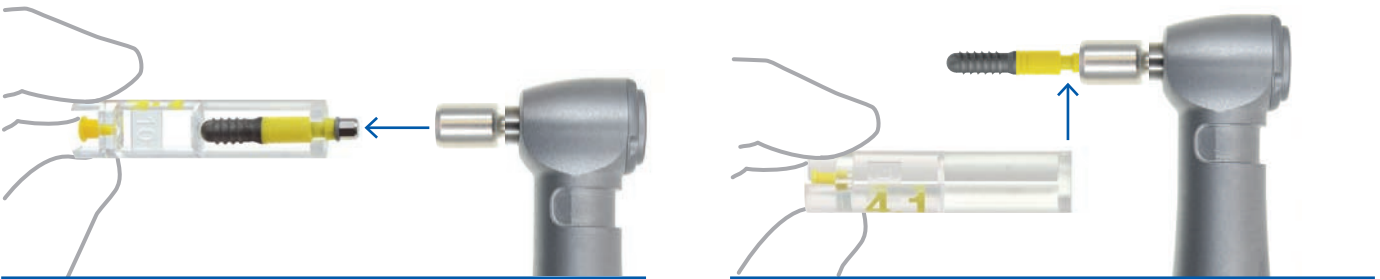

- for a manual placement, connect the surgical hand screwdriver to the implant carrier and remove the implant from the holder

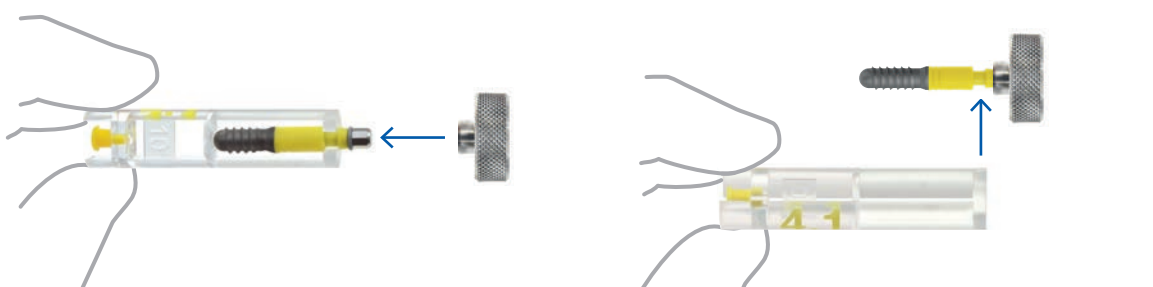

## DRILLING DEPTH

- the length of the drill tip (max. 1 mm) is not included in the depth mark measurements on the pilot and twist drills



## DEPTH STOPS FOR SHORT DRILLS

### Mounting of depth stop:

- insert the drill's tip into the hole of the drill stop kit corresponding to the diameter, the colour of the instrument and the selected depth
- push the drill all the way down to set the stop into position
- verify that the stop is positioned at the correct height

Note: if a stop loses stability, slightly tighten the clamping mechanism with tweezers



### Removal of depth stop\*

- insert the drill shank into the specific slot of the drill stop kit corresponding to the diameter of the drill
- place the specific tool for stop removal onto the tip of the drill and push down to remove the stop



\*Depth stops must be removed from the drills before cleaning, disinfection and sterilization.

DRILLING PROTOCOL FOR CLASSIX IMPLANTS

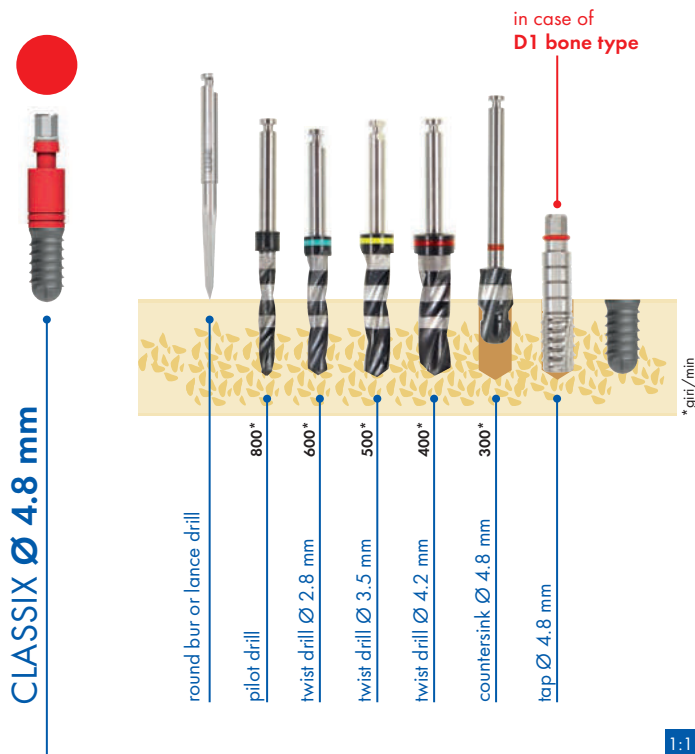
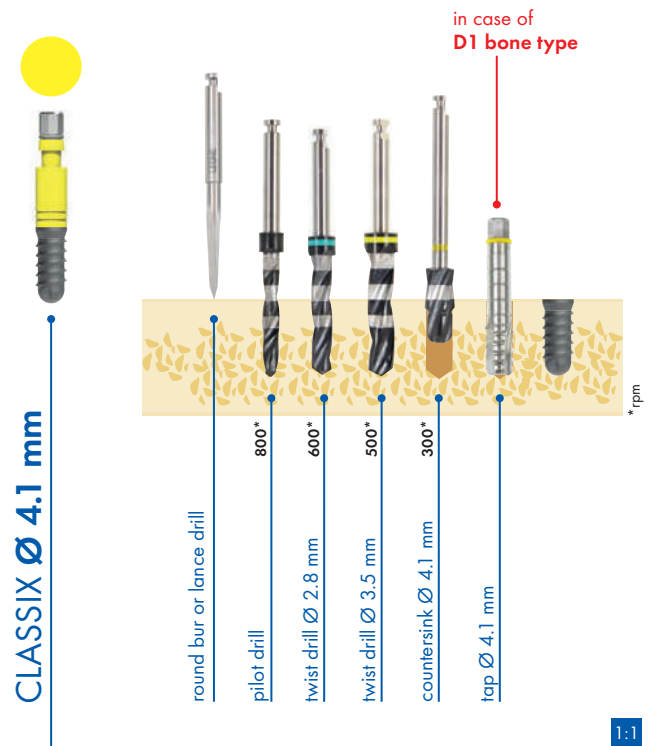
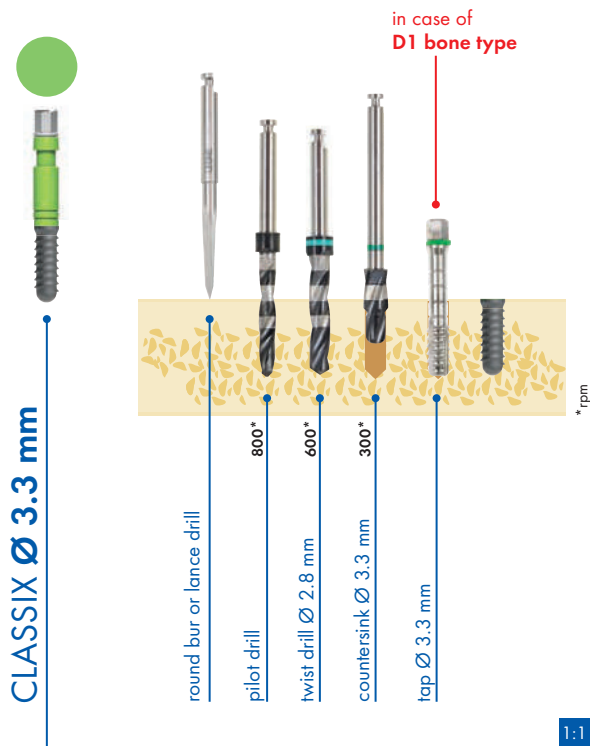

**HIGH BONE DENSITY - D1 BONE TYPE:**  
- the use of the tap is recommended

## DRILLING PROTOCOL FOR MAX STABILITY IMPLANTS

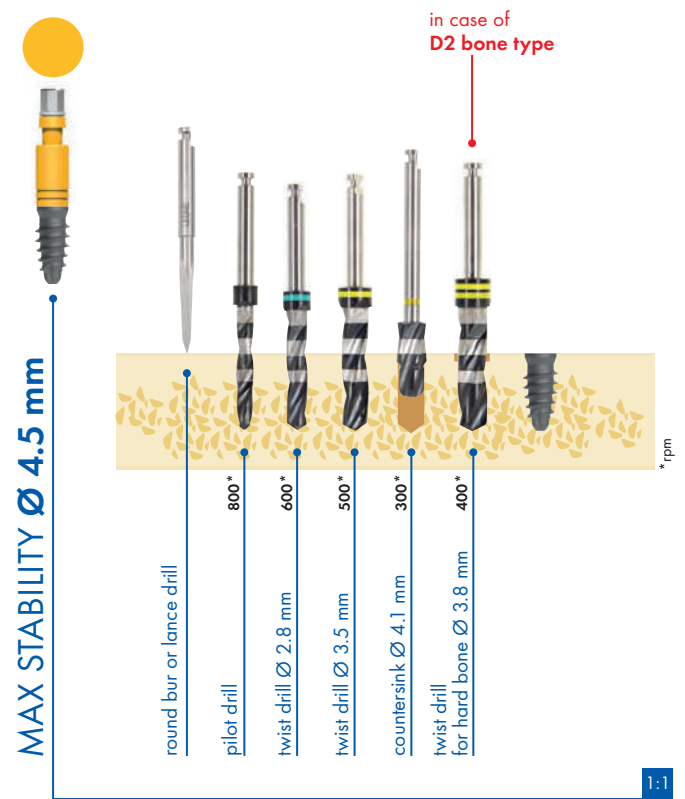
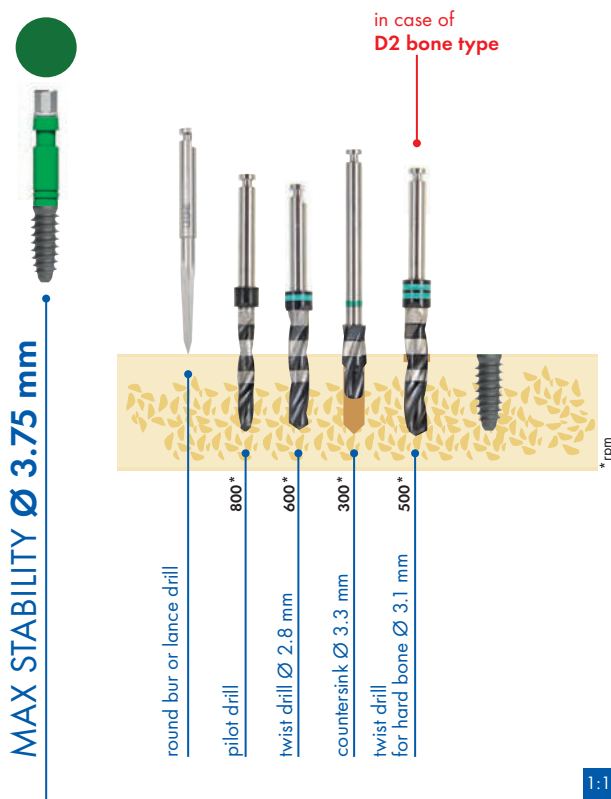

**Do not use Max Stability implants in thick cortical bone, equivalent to D1 bone type.**

### MEDIUM-TO-HIGH BONE DENSITY D2 BONE TYPE:

- it is necessary to use a twist drill with a larger diameter than the largest previously used, easily distinguishable by the two colour-coded marks on the shank.

two  
colour-coded  
marks



### FOR BETTER MAINTENANCE OF IMPLANT SITE AXIS:

- the use of the handpiece for the insertion of Max Stability implants is recommended.



DRILLING PROTOCOL FOR 2.9 NARROW IMPLANTS

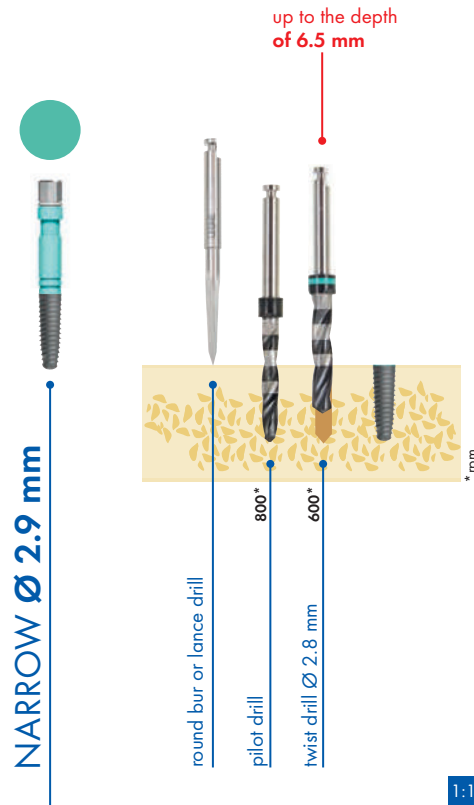

**Ø 2.8 mm TWIST DRILL:**

- use up to a depth of 6.5 mm for final sizing of the implant site. This depth is the same for all the three lengths of 2.9 Narrow implant.

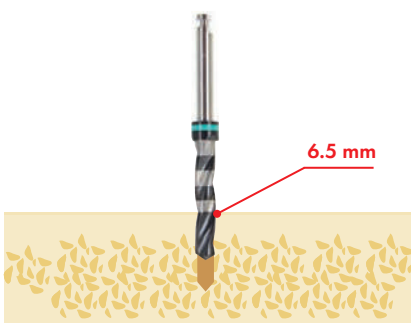

**HIGH BONE DENSITY - D1 BONE TYPE:**

- it is necessary to use the Ø 2.8 mm twist drill up to 2 mm less than the length of the selected implant (e.g. implant L = 10 mm, drill up to a depth of 8 mm).



**SUBCRESTAL IMPLANT PLACEMENT:**

- use the Ø 3.3 mm countersink to allow a complete seating of the healing cap.



## DRILLING PROTOCOL FOR 6.5 SHORT IMPLANT

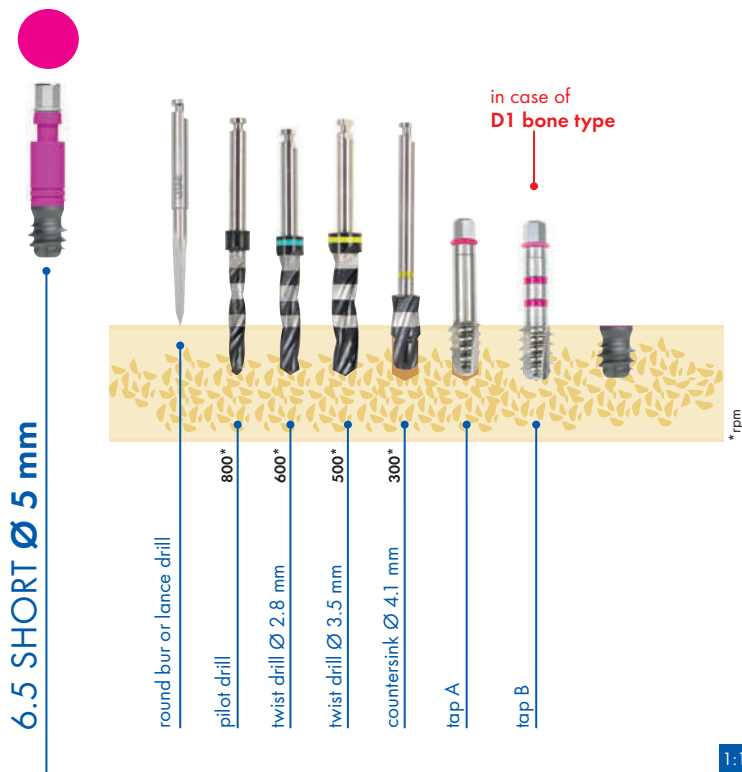

### PRIOR TO PLACING

#### A 6.5 SHORT IMPLANT:

- it is always necessary to use the tap "A" until the tap's threaded portion is totally inside the bone.

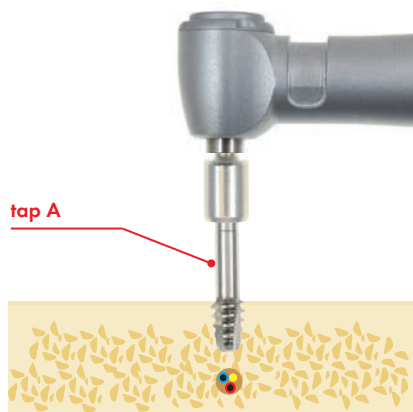

### HIGH BONE DENSITY - D1 BONE TYPE:

- the use of tap "B" is necessary after tapping with bone tap "A". Use also tap "B" until the tap's threaded portion is totally inside the bone; tap "B" is easy distinguishable by the two fuchsia coded marks on the shank.

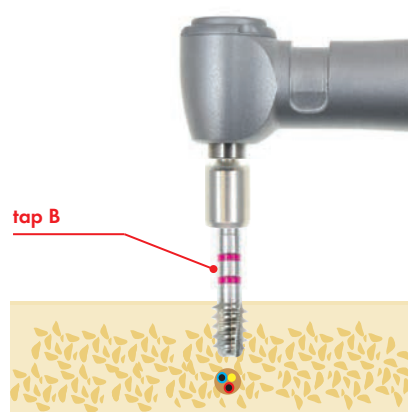

### FOR BETTER MAINTENANCE OF IMPLANT SITE AXIS:

- the use of the handpiece for tapping and insertion of 6.5 Short implant is recommended.



## 1. PREPARATION OF THE IMPLANT SITE: STEP-BY-STEP

### Illustrative protocol for **Classix Ø 4.1 L 10 mm implant**

**NOTE:**

- the use of the drills must be accompanied by adequate irrigation;
- in case of a subcrestal implant placement, take into account the planned level of implant placement when calculating the drilling depth.

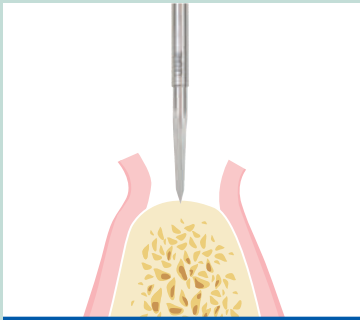

- Use the lance drill or round bur to mark the cortical bone for the subsequent drills.

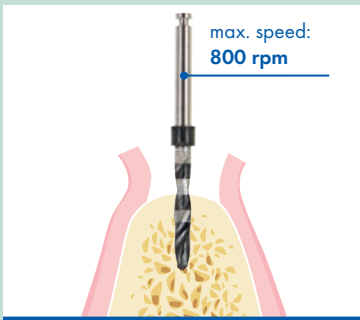

- Use the pilot drill up to the depth mark corresponding to the length of the selected implant.

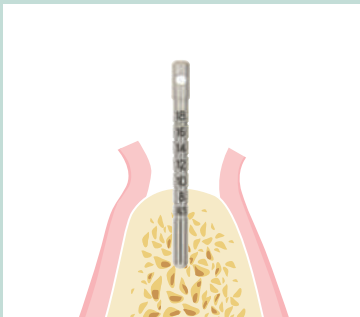

- Check the depth of the implant site with the depth gauge.

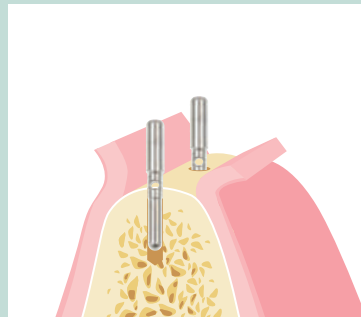

- Check parallelism with natural teeth and/or other adjacent implant sites with the paralleling pin.  
The paralleling pin can also be utilized after the application of the Ø 2.8 mm twist drill, taking care to seat the larger diameter in the implant site.

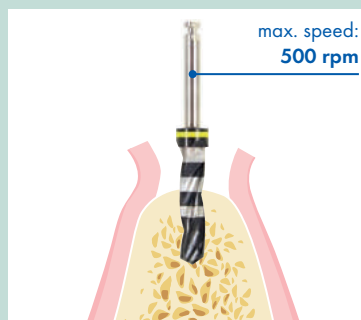
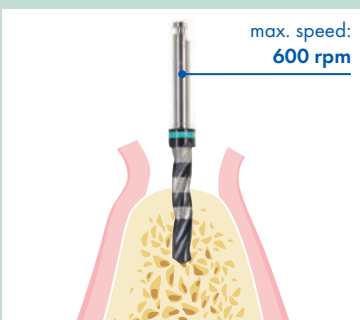

- Widen the diameter of the implant site with drills of increasing diameter. The drills have to be used up to the depth mark corresponding to the length of the selected implant.

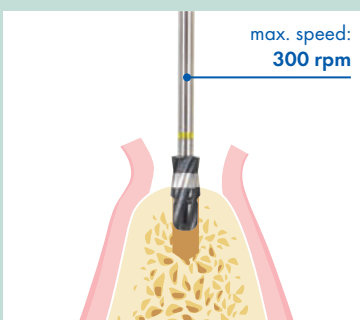

- Use the countersink to shape the osteotomy for the flared coronal portion of the implant.

**IN CASE OF  
HIGH BONE DENSITY**

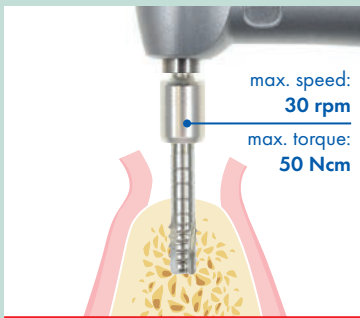

- In case of high bone density (D1 bone type), the use of the tap is recommended.

The tap can be connected either to the surgical hand screwdriver or to the handpiece. If there is not enough space for a direct connection between the tap and the instruments, the extension for instruments may be used. For use with a handpiece, connect the tap to the special adapter and set the micromotor to a max speed of 30 rpm and a max torque value of 50 Ncm.

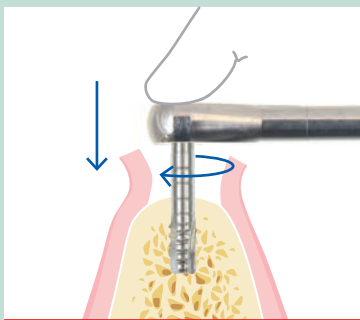
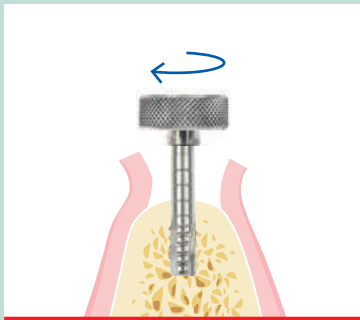

- Use the ratchet if the maximum torque value is not enough to complete tapping.



## 2. PLACEMENT OF THE IMPLANT: STEP-BY-STEP

Illustrative protocol for **Classix Ø 4.1 L 10 mm implant**

**NOTE:**

- the Classix implant can be screwed in with the help of the handpiece or of the surgical screwdriver; the use of the contra-angle handpiece ensures the maintenance of the implant site axis while driving the implant into the surgical cavity;
- insert the implant without irrigation.

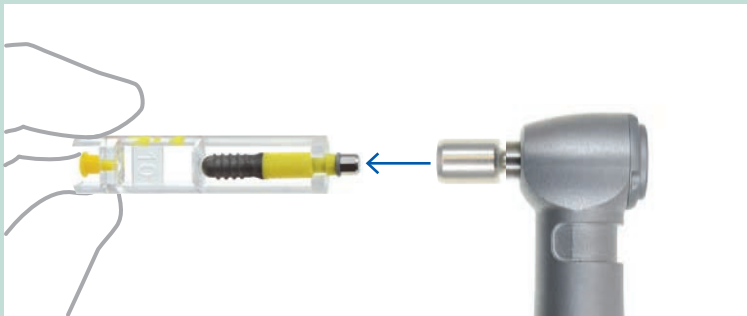

- Connect the handpiece adapter to the carrier of the implant and extract the implant from the holder. If there is not enough length with the carrier and adapter to reach the implant site, the extension for instruments may be used.

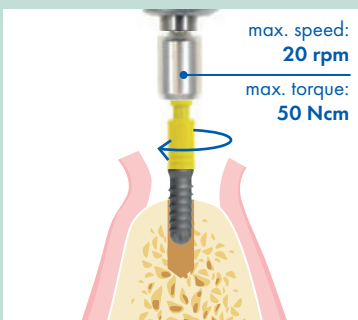
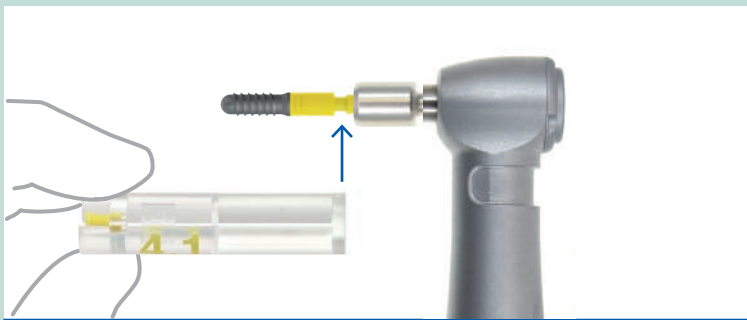

- Set a micromotor's maximum speed to 20 rpm and a max. torque value to 50 Ncm.
- Insert the implant up to the prepared level.

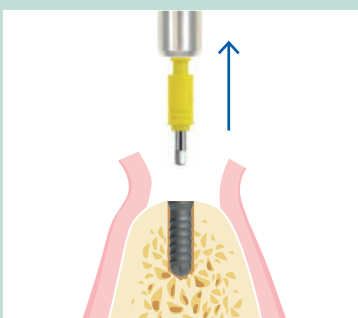

- Remove the carrier from the implant by pulling it out.

**IF IMPLANT INSERTION IS DIFFICULT**

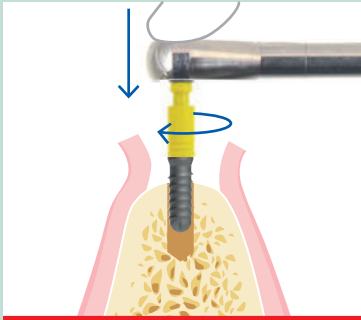

- If the pre-set maximum torque value is not sufficient to complete implant insertion, remove the handpiece adapter from the carrier and attach the ratchet. It is recommended to keep the instrument well aligned by keeping a finger on the head of the instrument, avoiding flexion.

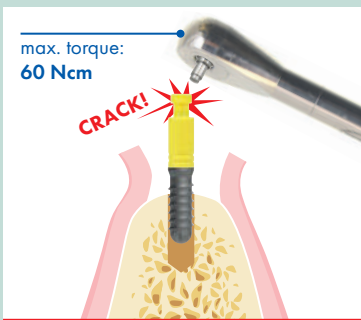

- When using a ratchet, the forces exerted on the implant and the correspondent periimplant bone can become excessive. In this eventuality, should a value of 60 Ncm be exceeded, a torque limiting device makes the carrier break above the connection with the implant and then the carrier can be removed.

Note that carrier fracture is not always visible, but it is detectable by a sudden loss of functionality of the insertion instrument accompanied by a sharp crack.

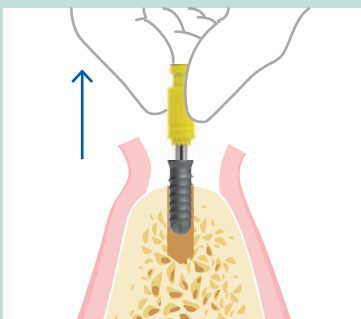

- If fractured, remove the carrier.

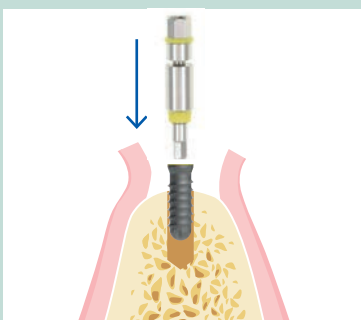

- Replace the carrier with the High Torque driver for 3.0 connection which withstands torque values up to 160 Ncm.

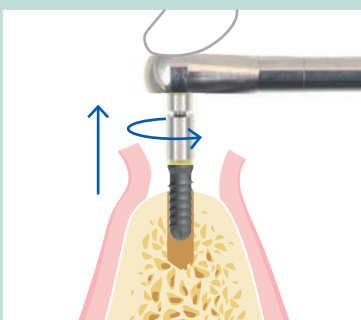

- Attach the ratchet to the driver and remove the implant from the implant site.
- Tap the site and place the implant again.

### 3. HEALING OPTIONS

After implant placement, it is possible to choose among several healing options:

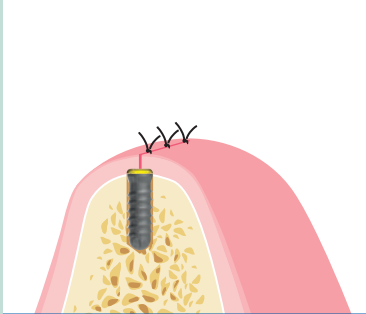

3.1

**TWO-STAGE TECHNIQUE  
WITH COVER CAP**  
supplied with the implant package

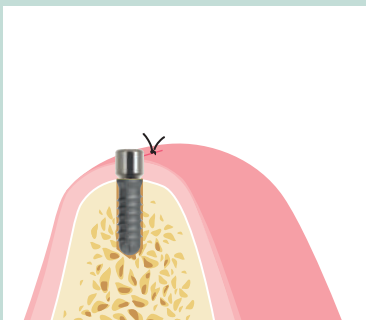

3.2

**ONE-STAGE TECHNIQUE  
WITH HEALING CAP**

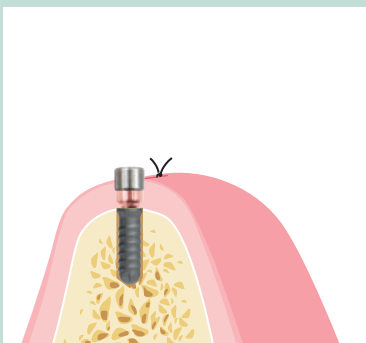

3.3

**TRANSGINGIVAL HEALING  
WITH EXACONNECT PLUS**  
(if a single unit screw-retained restoration is planned)

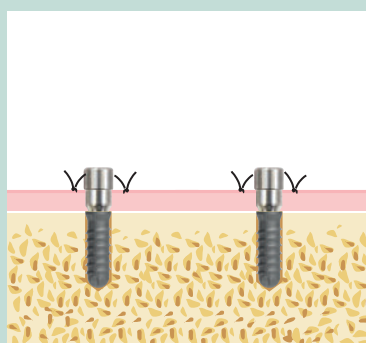

3.4

**TRANSGINGIVAL HEALING  
WITH MUA PLUS**  
(if a multi unit screw-retained restoration is planned)



As an alternative, after a thorough evaluation by a clinical expert, it is possible to opt for an immediate loading procedure.

### 3.1 TWO-STAGE SURGICAL PROCEDURE: FIRST STAGE

**NOTE:**

- if you have planned a subcrestal implant placement, use a GH 1.5 healing cap instead of the cover cap included in the implant package, to avoid bone growth on the cap.

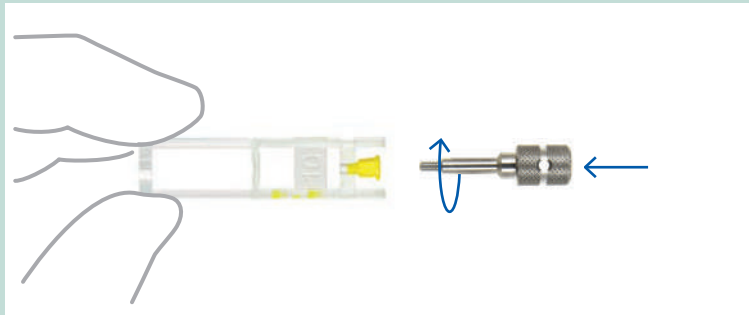

- Take the holder that previously contained the implant.

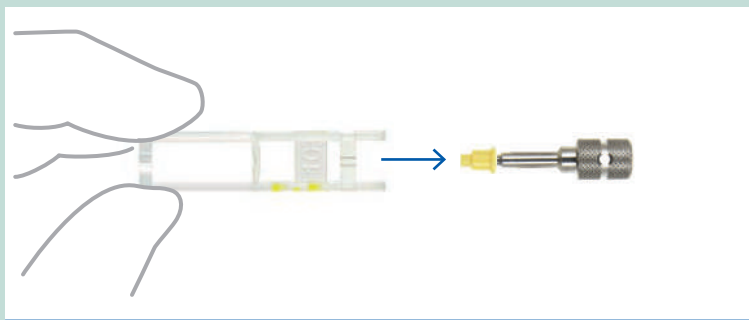

- Screw the instrument for cover caps onto the head of the cover cap. Remove the biopolymer cover cap from the holder with a gentle extraction.

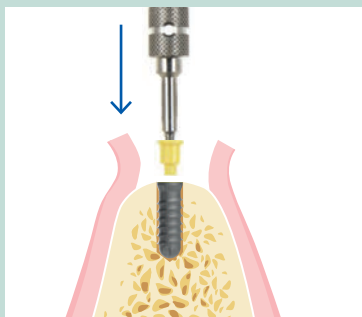

- After rinsing and drying of the inner part of the implant, insert the cap into the implant and press down.

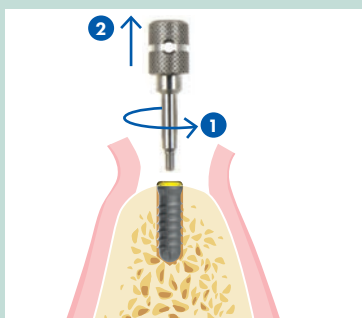

- Unscrew the instrument for cover caps.

- Press on the cap with a blunt instrument to make sure it is pushed all the way down.

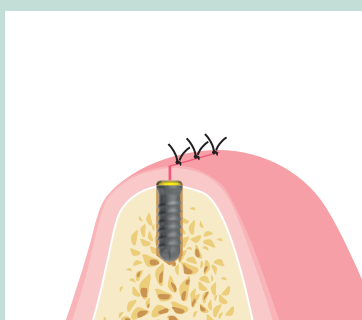

- The soft tissue is sutured over the implant.

### 3.1 TWO-STAGE SURGICAL PROCEDURE: SECOND STAGE

**NOTE:**

- select the healing cap according to the connection diameter ( $\varnothing$  2.2 mm green,  $\varnothing$  3.0 mm yellow), the gingival thickness and the prosthetic platform diameter.

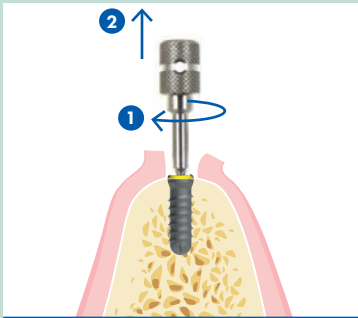

- Once osseointegration has occurred, make an incision to expose the implant and remove the cover cap with the specific instrument for cover caps.
- Screw the instrument for cover caps onto the head of the cover cap and remove by pulling it out.
- Rinse and dry the inner part of the implant.

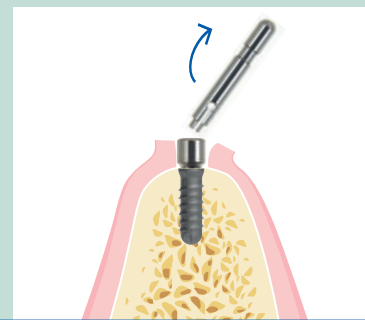
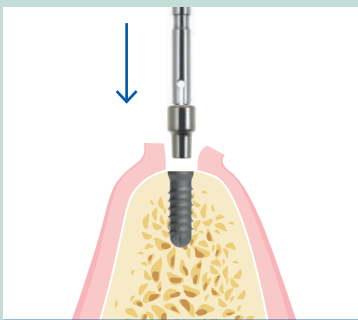

- Open the glass vial and extract the inner holder containing the sterile healing cap mounted on the carrier.
- Place the cap into the implant and exert a pressure on the carrier.
- Remove the carrier with a gentle side bending.

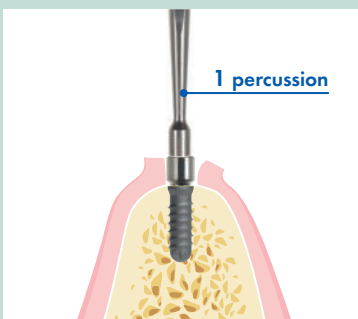

- Activate the locking-taper connection by applying a percussive force. We recommend to perform **1 percussion** with the specific abutment seater with titanium tip.

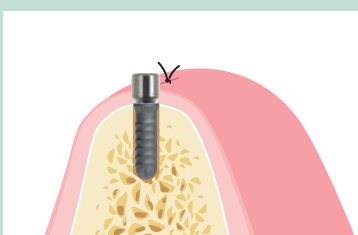

- Suture the soft tissues around the healing cap.

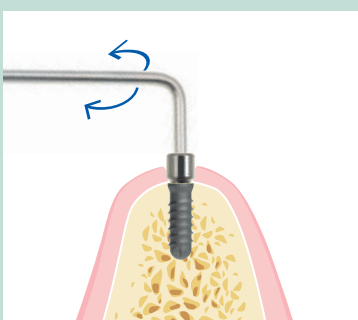

- When the healing process has occurred, unlock the healing cap by means of the specific hex head extractor.
- Seat the extractor into the hexagon on the head of the healing cap and rotate either clockwise or counter clockwise to unlock the healing cap.
- Use tweezers to remove the cap from the implant.

For impression taking, the preparation of the abutment and the fabrication of the final prosthesis, refer to the "Prosthetic procedure" page 113

### 3.2 ONE-STAGE SURGICAL PROCEDURE

**NOTE:**

- select the healing cap according to the connection diameter (Ø 2.2 mm green, Ø 3.0 mm yellow), the gingival thickness and the prosthetic platform diameter of the abutment;
- in case of flapless procedure and subcrestal implant placement, use Standard healing caps.

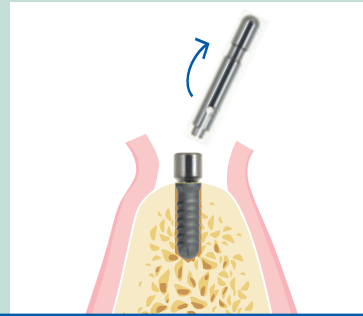
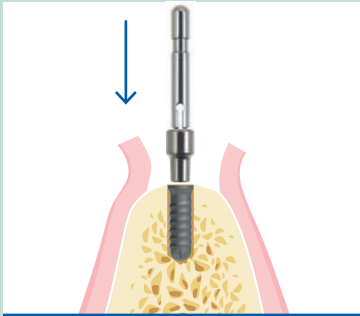

- Rinse and dry the inner part of the implant.
- Open the glass vial and extract the inner holder containing the sterile healing cap mounted on the carrier.
- Place the cap into the implant and exert a pressure on the carrier.
- Remove the carrier with a gentle side bending.

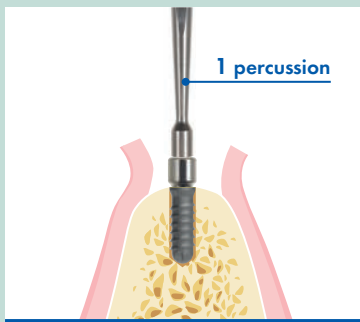

- Activate the locking-taper connection by applying a percussive force. We recommend to perform **1 percussion** with the specific abutment seater with titanium tip.

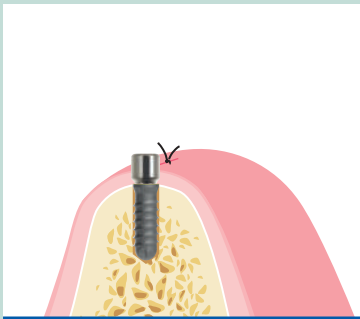

- Suture the soft tissues around the healing cap.

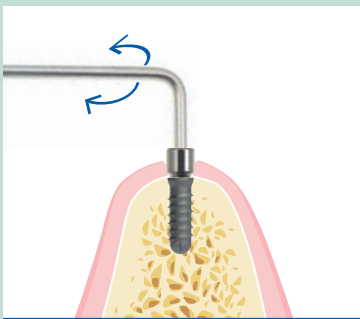

- When the osseointegration has occurred, unlock the healing cap by means of the specific hex head extractor.
- Seat the extractor into the hexagon on the head of the healing cap and rotate either clockwise or counter clockwise to unlock the healing cap.
- Use tweezers to remove the cap from the implant.

For impression taking, the preparation of the abutment and the fabrication of the final prosthesis, refer to the "Prosthetic procedure" page 113

### 3.3 TRANSGINGIVAL HEALING WITH EXACONNECT PLUS



**NOTE:**

- select the ExaConnect Plus according to the connection diameter ( $\varnothing$  2.2 mm green,  $\varnothing$  3.0 mm yellow);
- use the Abutment Gauges to choose the most suitable ExaConnect Plus in terms of GH and angulation;
- ExaConnect Plus with green connection ( $\varnothing$  2.2 mm) has a  $\varnothing$  4.1 mm prosthetic platform; in case of subcrestal implant placement, it may be necessary to use the  $\varnothing$  4.5 mm Bone Profiler to allow the complete seating of the ExaConnect Plus.

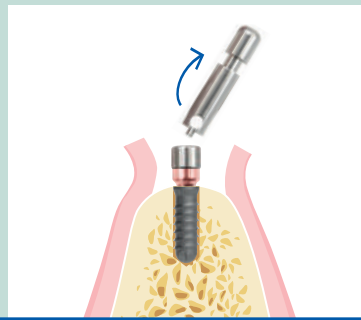
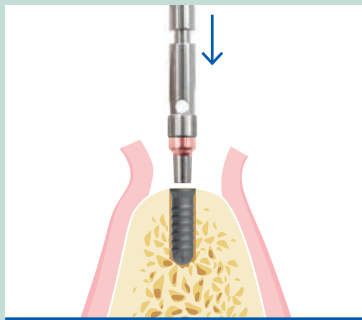

- Rinse and dry the inner part of the implant.
- Open the glass vial and extract the inner holder containing the sterile ExaConnect Plus with its healing screw mounted on the carrier.
- Place the ExaConnect Plus into the implant and rotate the connector to find the correct position.
- Exert a pressure on the carrier.  
Remove the carrier with a gentle side bending.

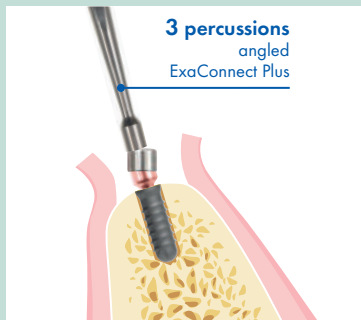
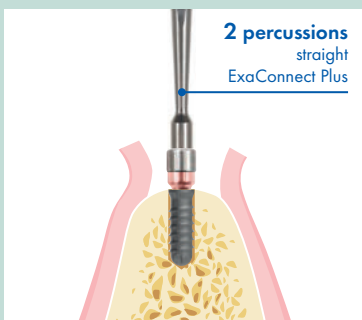

- Place the specific abutment seater with titanium tip on the healing screw pre-mounted on the ExaConnect Plus.
- In order to activate the locking-taper connection perform:  
**2 percussions onto the straight ExaConnect Plus**  
**3 percussions onto the angled ExaConnect Plus**  
(by aligning the instrument along the implant axis).

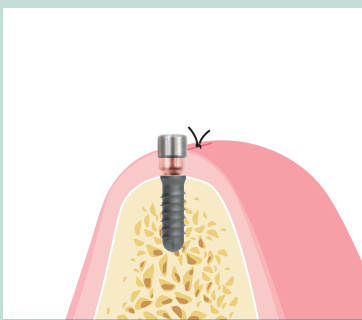

- Suture the soft tissues around the ExaConnect Plus.

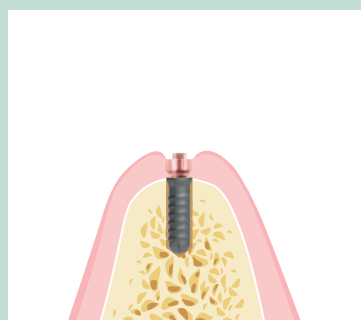
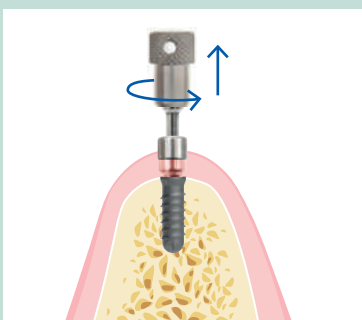

- When the osseointegration has occurred, unscrew the healing screw by means of the specific short adapter for screws mounted on the prosthetic hand screwdriver.

The ExaConnect remains in place.  
The impression taking and the restoration will be done on the ExaConnect.

For impression taking, the preparation of the abutment and the fabrication of the final prosthesis, refer to the "Prosthetic procedure" page 113

### 3.4 TRANSGINGIVAL HEALING WITH MUA PLUS



**NOTE:**

- select the MUA Plus according to the connection diameter (Ø 2.2 mm green, Ø 3.0 mm yellow);
- use the Abutment Gauges to choose the most suitable MUA Plus in terms of GH and angulation.

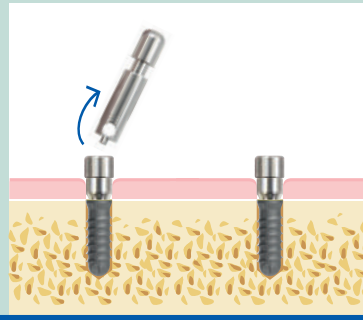
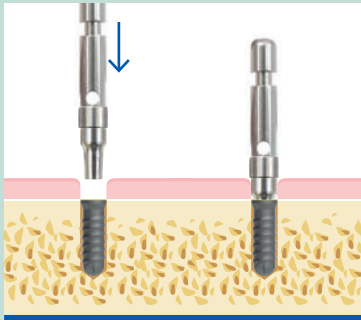

- Rinse and dry the inner part of the implant.
- Open the glass vial and extract the inner holder containing the sterile MUA Plus with its healing screw mounted on the carrier.
- Place the MUA Plus into the implant and rotate to find the correct position.
- Exert a pressure on the carrier.  
Remove the carrier with a gentle side bending.

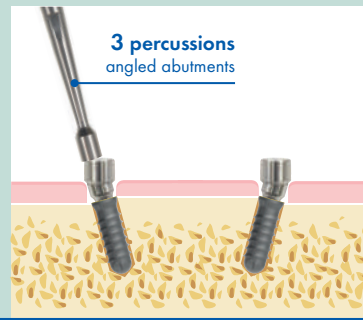
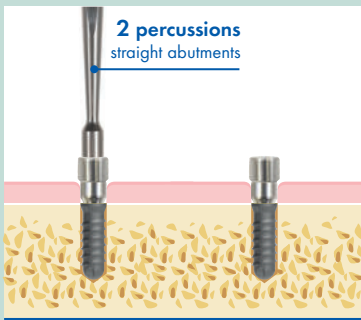

- Place the specific abutment seater with titanium tip on the healing screw pre-mounted on the MUA Plus.
- In order to activate the locking-taper connection perform,  
**2 percussions onto the straight abutments**  
**3 percussions onto the angled abutments**  
(by aligning the instrument along the implant axis).

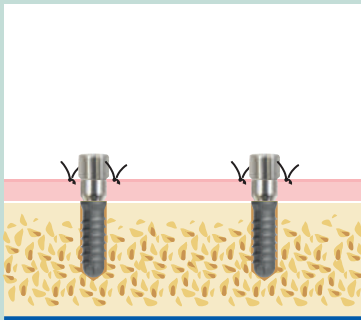

- Suture the soft tissues around the MUA Plus.

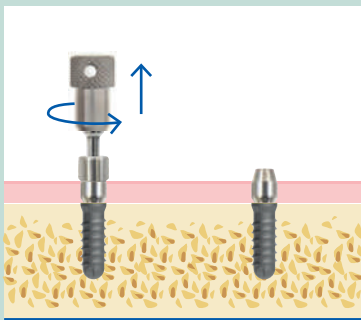

- When the osseointegration has occurred, unscrew the healing screw by means of the specific short adapter for screws mounted on the prosthetic hand screwdriver.

The MUA remains in place.  
The impression taking and the restoration will be done on the MUA.

For impression taking and the fabrication of the final prosthesis, refer to the "Prosthetic procedure" page 113



## XCN<sup>®</sup> IMPLANT SYSTEM

---

# PROSTHETIC PROCEDURE



The pictures and illustrations in this brochure are for information purposes only and they are not intended to replace the methods or procedures for diagnosis and treatment planning of the Dental surgeon, Dentist and Dental Technician regarding the needs of each patient. Leone Spa disclaims any liability or any other obligation expressed or implied in this brochure.



DISCLAIMER

The Prosthetic Procedure and the use of the products of the XCN® Leone Implant System described in the following pages are intended for Professionals experienced in dental implant techniques.



In case of lack of basic notions, we suggest to attend specific courses in order to reach a high level of knowledge and practice in the use of implants. The rules on the use of the products described below represent a group of standard instructions that must be adjusted to the single needs and to the particular situations that may occur according to the manual ability, to the experience and to the diagnosis made by the legally qualified medical operator. It is not ascribed to the manufacturer the duty of monitoring the procedures of use of the product. A correct and appropriate use of the instruments and products related to the XCN® Leone Implant System shall completely be reverted to the clinician. The surgical procedure hereunder described is merely indicative as any single treatment case is assigned to the experience of the operator. As every medical operator well knows, a correct procedure and a perfect manufacture of the prosthesis may sometimes be followed by not satisfactory results owing to particular situations not imputable to responsibility of the dental operator or the manufacturer.

PREMISE

The Leone implant system offers the ability to fabricate fixed cement-and screw-retained prostheses, fixed and removable conometric-retained prostheses as well as bar-and attachment-retained prostheses.

The following pages describe the prosthetic workflow step-by-step for every single indication. For a detailed description of each step, please refer to the online version of the prosthetic procedure and to the associated explainer videos:

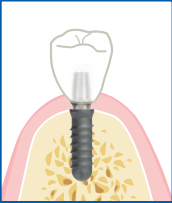
[www.leone.it/prostheticprocedure](http://www.leone.it/prostheticprocedure)

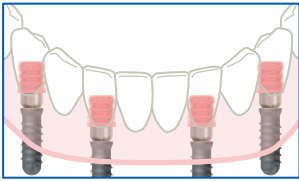
		CONVENTIONAL WORKFLOW	DIGITAL WORKFLOW	
		PAGES		
SINGLE CROWN		<b>CEMENT-RETAINED</b>	TEMPORARY ABUTMENT, STANDARD AND LARGE ..... 115	127, 128
			BASIC ABUTMENT, STANDARD AND LARGE ..... 115	127, 128
			360° ANATOMICAL ABUTMENT, STANDARD AND LARGE ..... 115	127, 128
			MULTITECH ABUTMENT ..... 115	126, 127, 128
			TI-BASE ABUTMENT ..... 115	125, 126
<b>SCREW-RETAINED</b>	EXACONNECT ..... 116, 117	129, 130, 131, 132		
	BRIDGE		<b>CEMENT-RETAINED</b>	TEMPORARY ABUTMENT, STANDARD AND LARGE ..... 118
BASIC ABUTMENT, STANDARD AND LARGE ..... 118				127, 128
360° ANATOMICAL ABUTMENT, STANDARD AND LARGE ..... 118				127, 128
MULTITECH ABUTMENT ..... 118				127, 128
<b>SCREW-RETAINED</b>				MUA ..... 119, 120
	<b>CONOMETRIC-RETAINED</b>	MUA-CONIC →	FIXED CAP ..... 121	136, 137
WELDING CAP ..... 122				
REMOVABLE PROSTHESIS		<b>BAR-RETAINED</b>	MUA ..... 119	133, 134, 135
			<b>ATTACHMENT-RETAINED</b>	BALL HEAD ABUTMENT →
		HOUSING WITH INSERT ..... 123		
		MICRO HOUSING WITH O-RING ..... 123		
		<b>CONOMETRIC-RETAINED</b>	MUA-CONIC →	MOBILE CAP ..... 124

**NOTE:** the patient should be given appropriate post-operative instructions in order to prevent complications and variations in the efficiency of the device: a good level of oral hygiene and periodical checkups are recommended.

The Prosthetic Procedure reported was conceived with the invaluable contribution of Dental Technician Mr. Massimiliano Pisa, whom we thank sincerely.

CONVENTIONAL PROSTHETIC WORKFLOW

CEMENT-RETAINED SINGLE CROWN

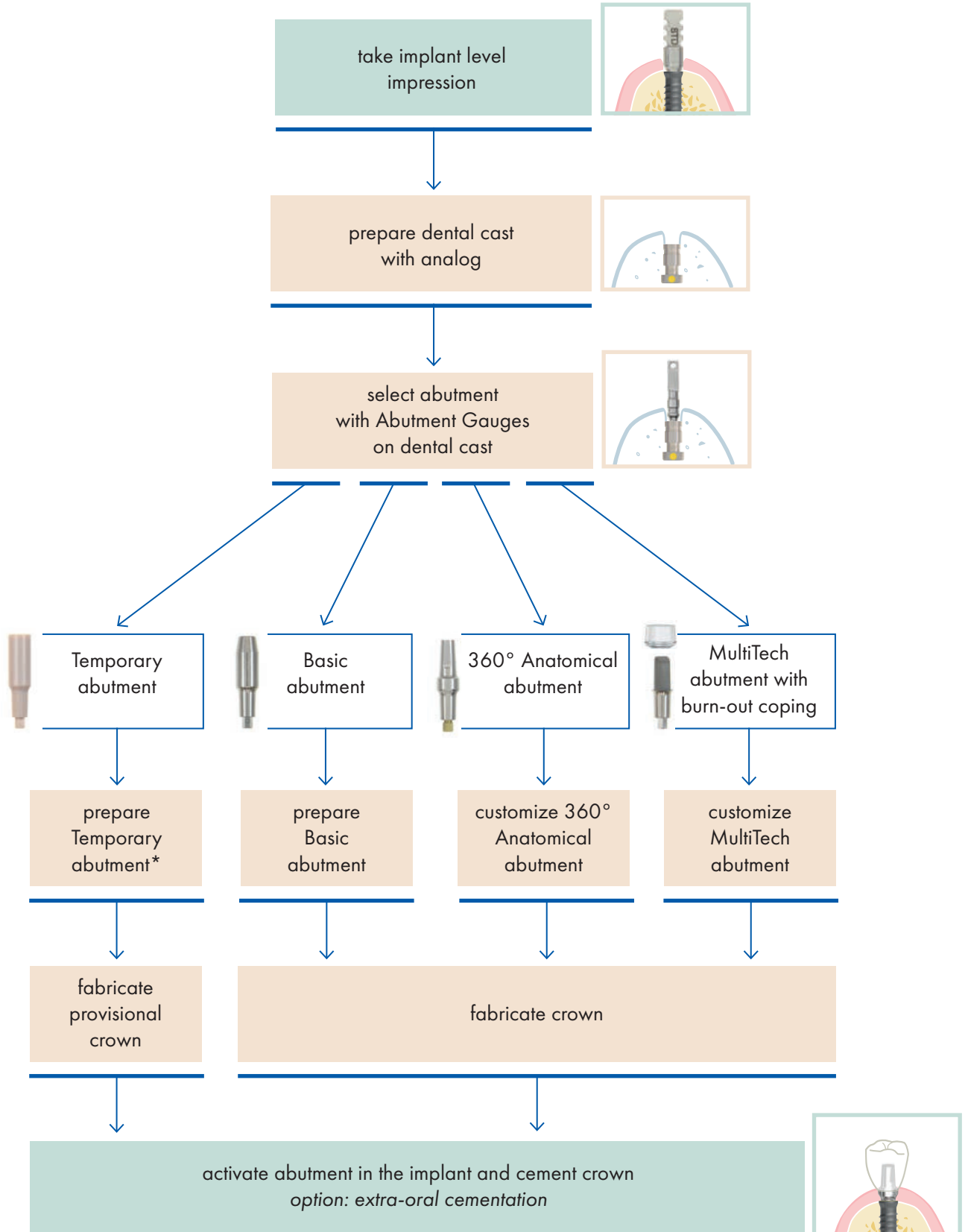

\*The Temporary abutment and the provisional crown may also be selected and fabricated in the dental office.

CONVENTIONAL PROSTHETIC WORKFLOW



SCREW-RETAINED SINGLE CROWN - ABUTMENT LEVEL

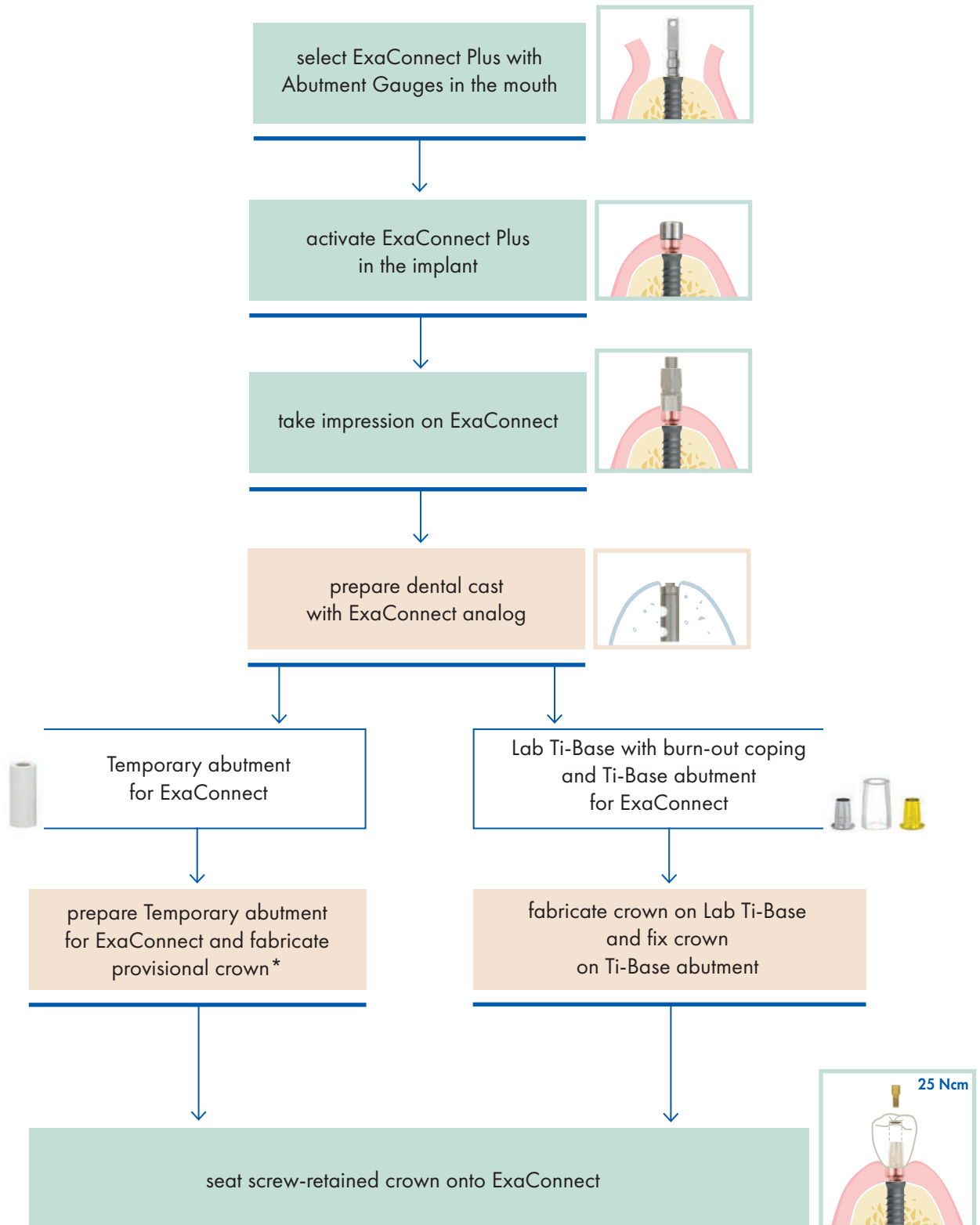

\*The Temporary abutment and the provisional crown may also be selected and fabricated in the dental office.

CONVENTIONAL PROSTHETIC WORKFLOW



SCREW-RETAINED SINGLE CROWN - IMPLANT LEVEL

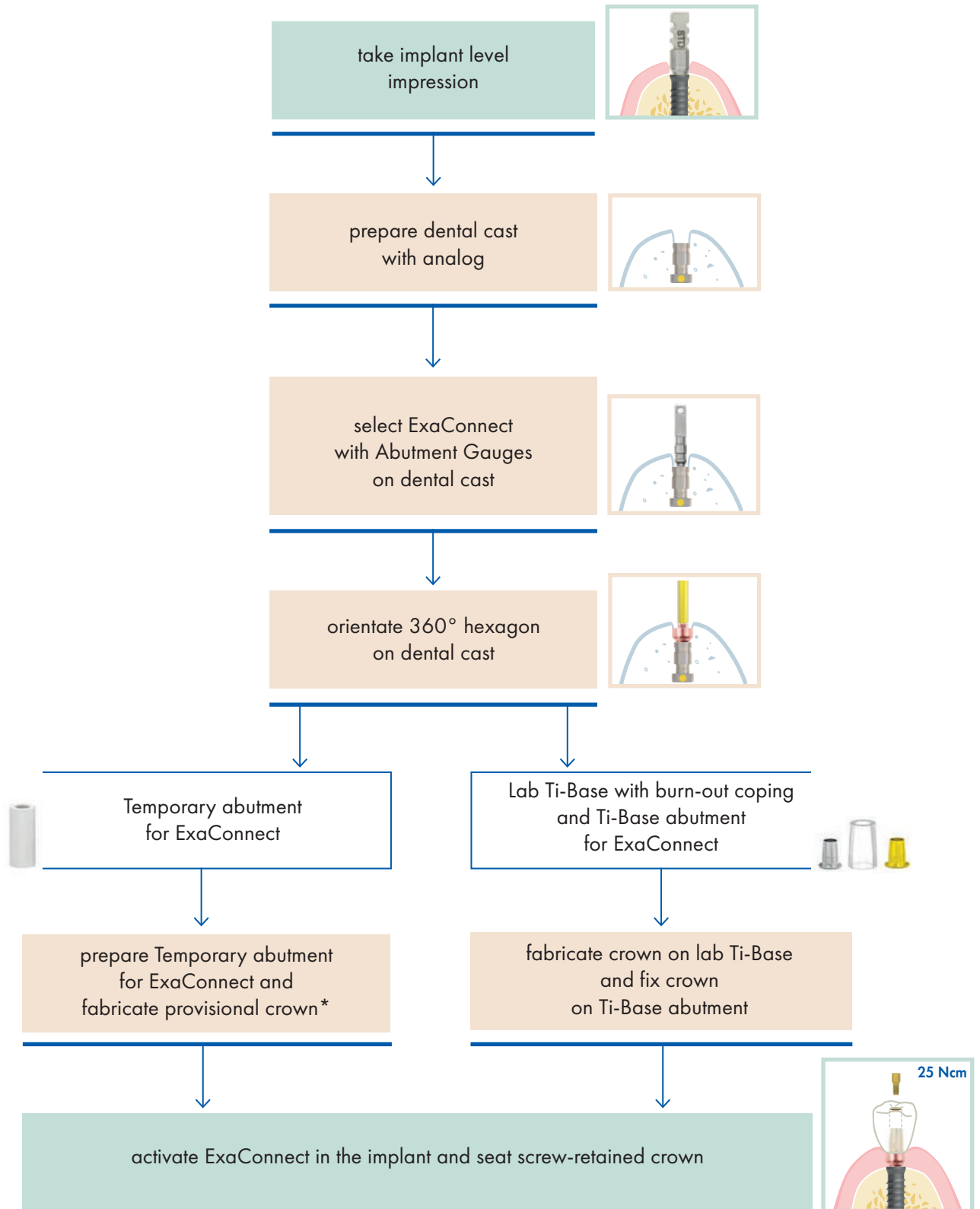

\*The Temporary abutment and the provisional crown may also be selected and fabricated in the dental office

CONVENTIONAL PROSTHETIC WORKFLOW

CEMENT-RETAINED BRIDGE

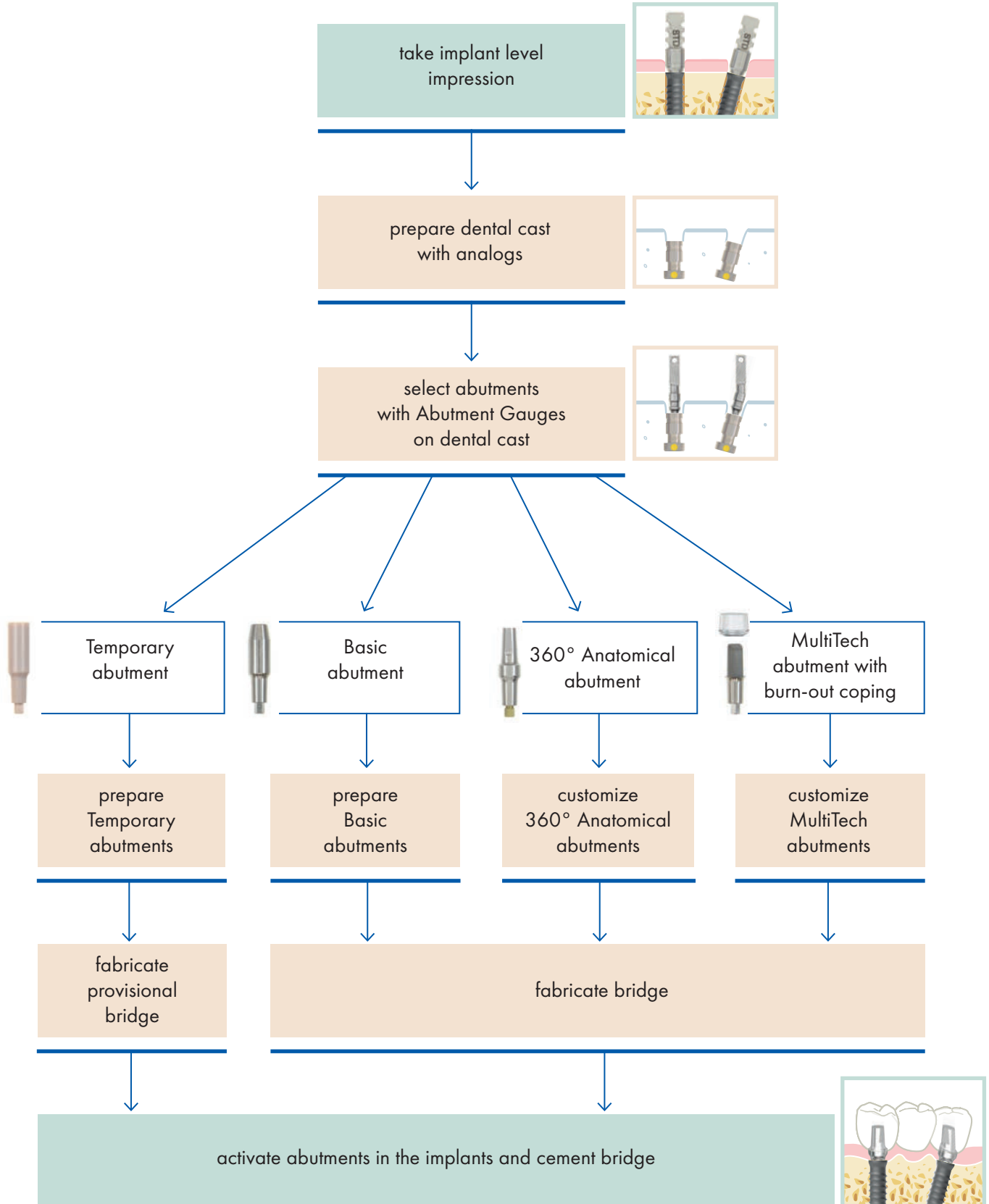

→ Steps carried out by **THE CLINICIAN**
→ Steps carried out by **THE DENTAL LABORATORY**

CONVENTIONAL PROSTHETIC WORKFLOW



**SCREW-RETAINED BRIDGE/BAR**

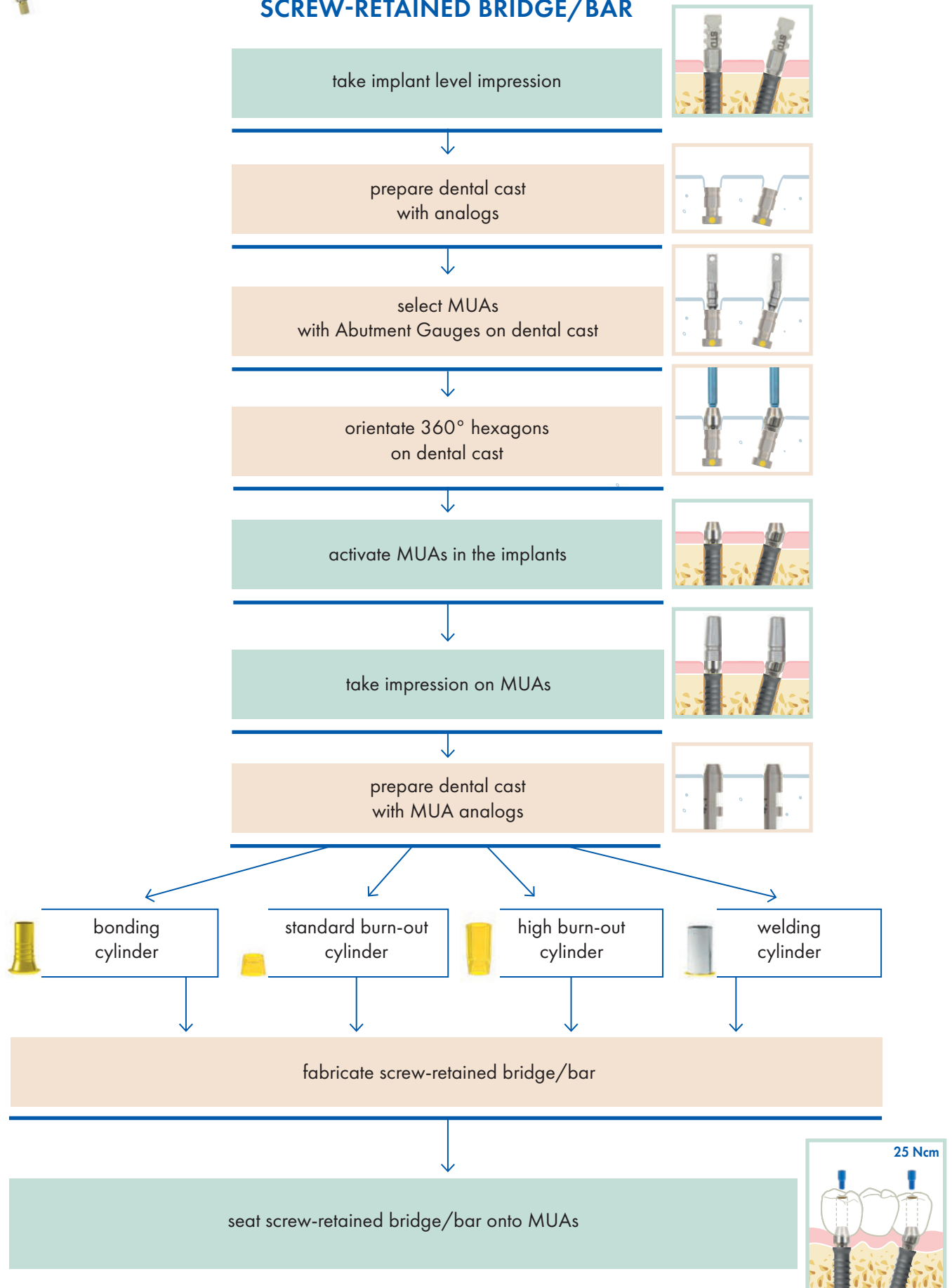

→ Steps carried out by **THE CLINICIAN**
→ Steps carried out by **THE DENTAL LABORATORY**

CONVENTIONAL PROSTHETIC WORKFLOW



**ALL-ON-FOUR  
IMMEDIATE LOADING**

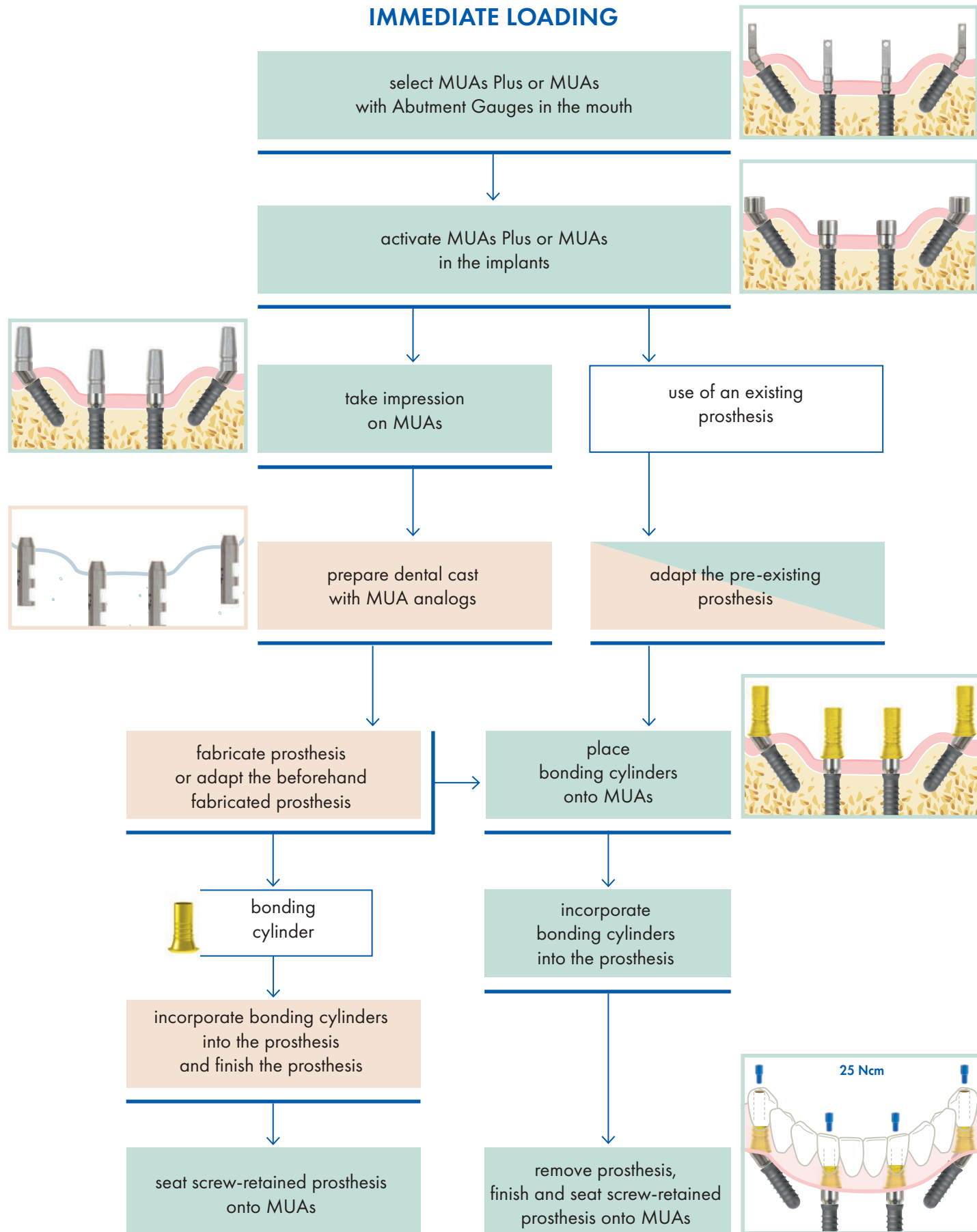

→ Steps carried out by **THE CLINICIAN**
→ Steps carried out by **THE DENTAL LABORATORY**



CONVENTIONAL PROSTHETIC WORKFLOW

CONOMETRIC-RETAINED BRIDGE WITH FIXED CAPS

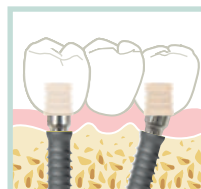
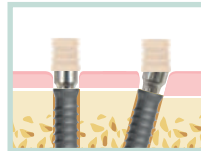
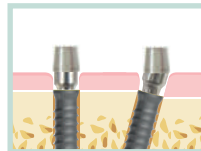
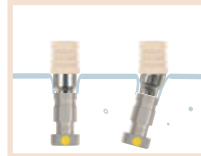
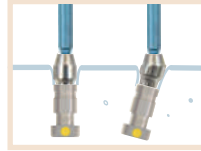
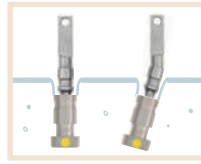
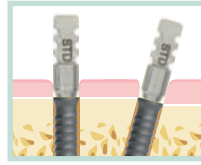
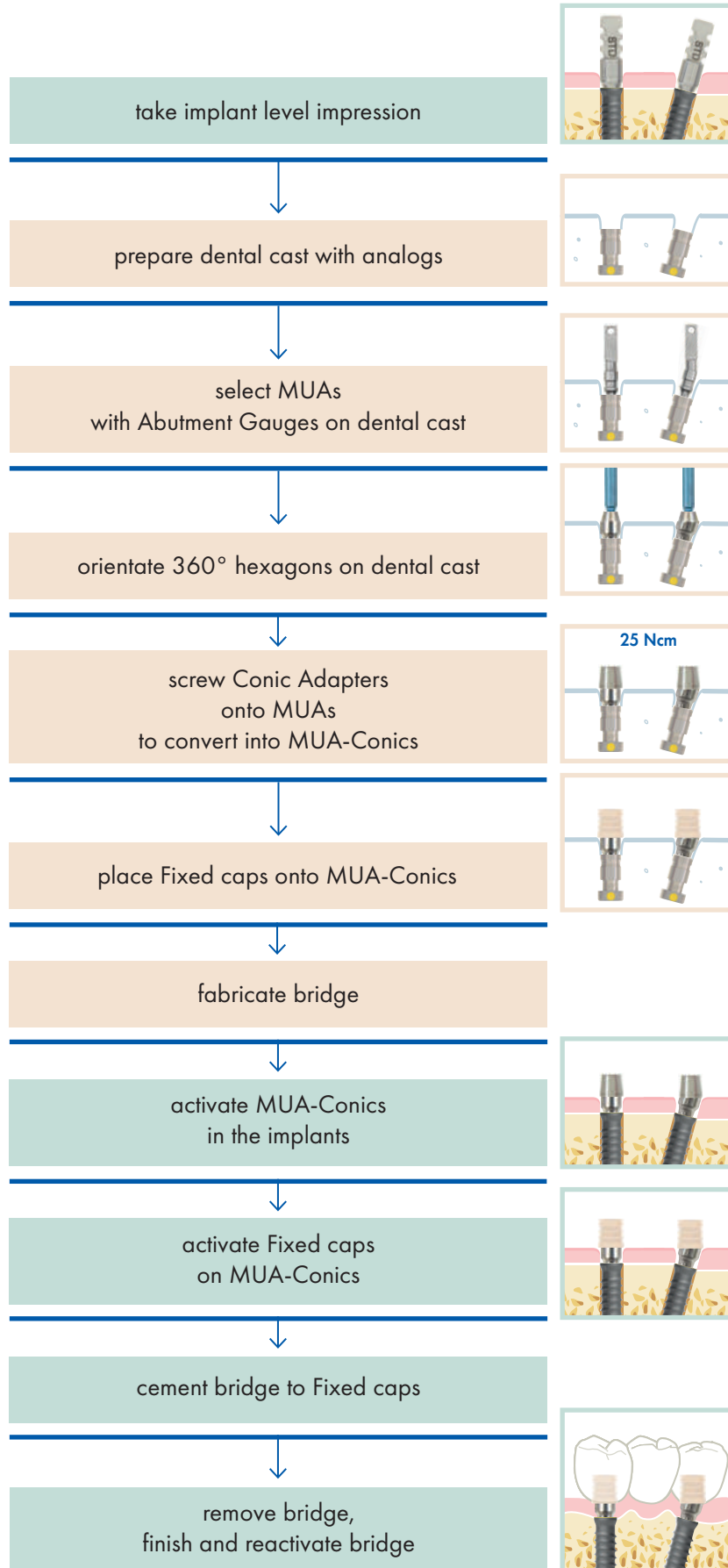

→ Steps carried out by THE CLINICIAN

→ Steps carried out by THE DENTAL LABORATORY

CONVENTIONAL PROSTHETIC WORKFLOW

CONOMETRIC-RETAINED BRIDGE WITH WELDING CAPS  
IMMEDIATE LOADING

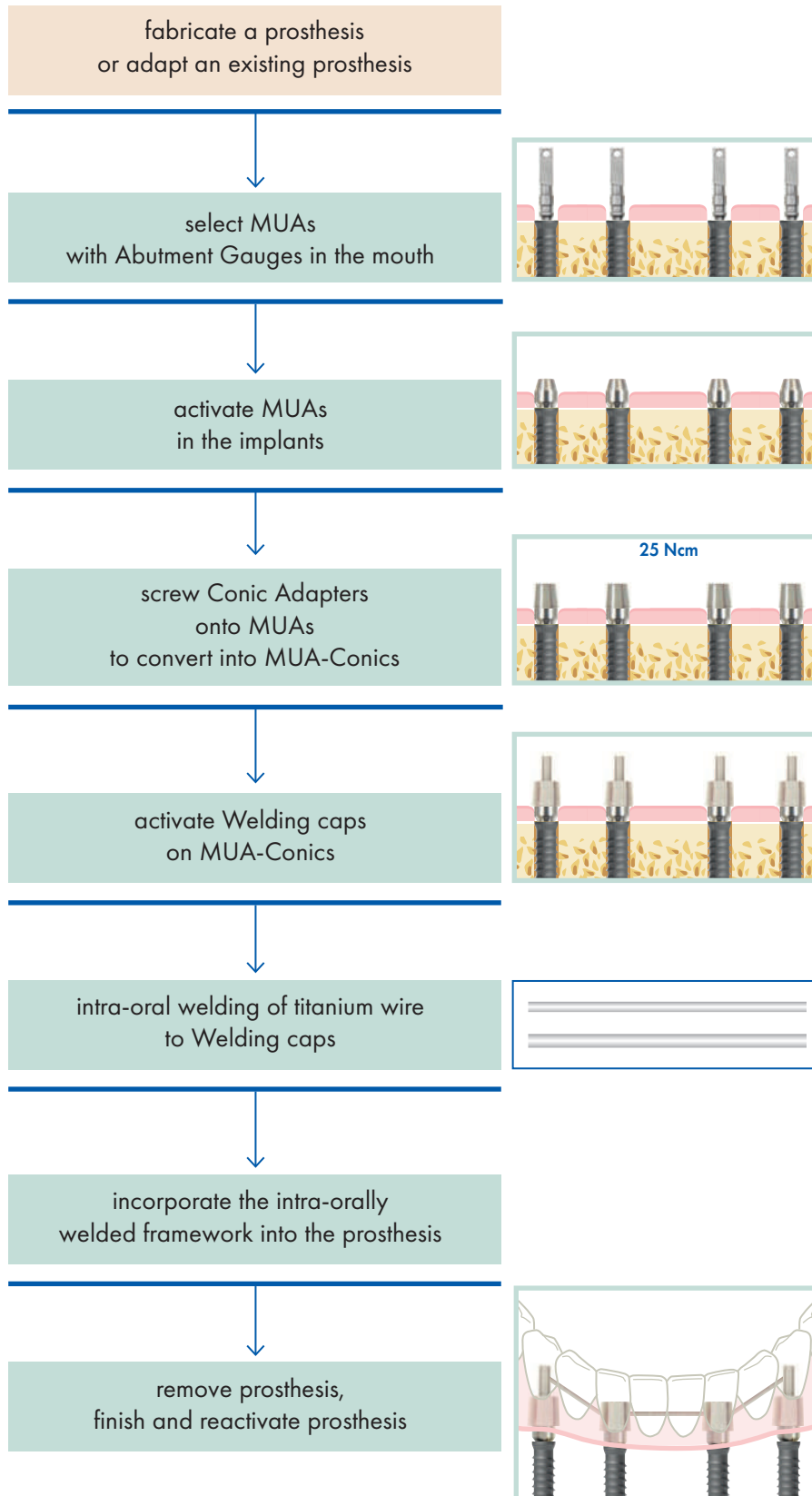

→ Steps carried out by THE CLINICIAN

→ Steps carried out by THE DENTAL LABORATORY

CONVENTIONAL PROSTHETIC WORKFLOW



REMOVABLE PROsthESIS ON BALL HEAD ABUTMENTS

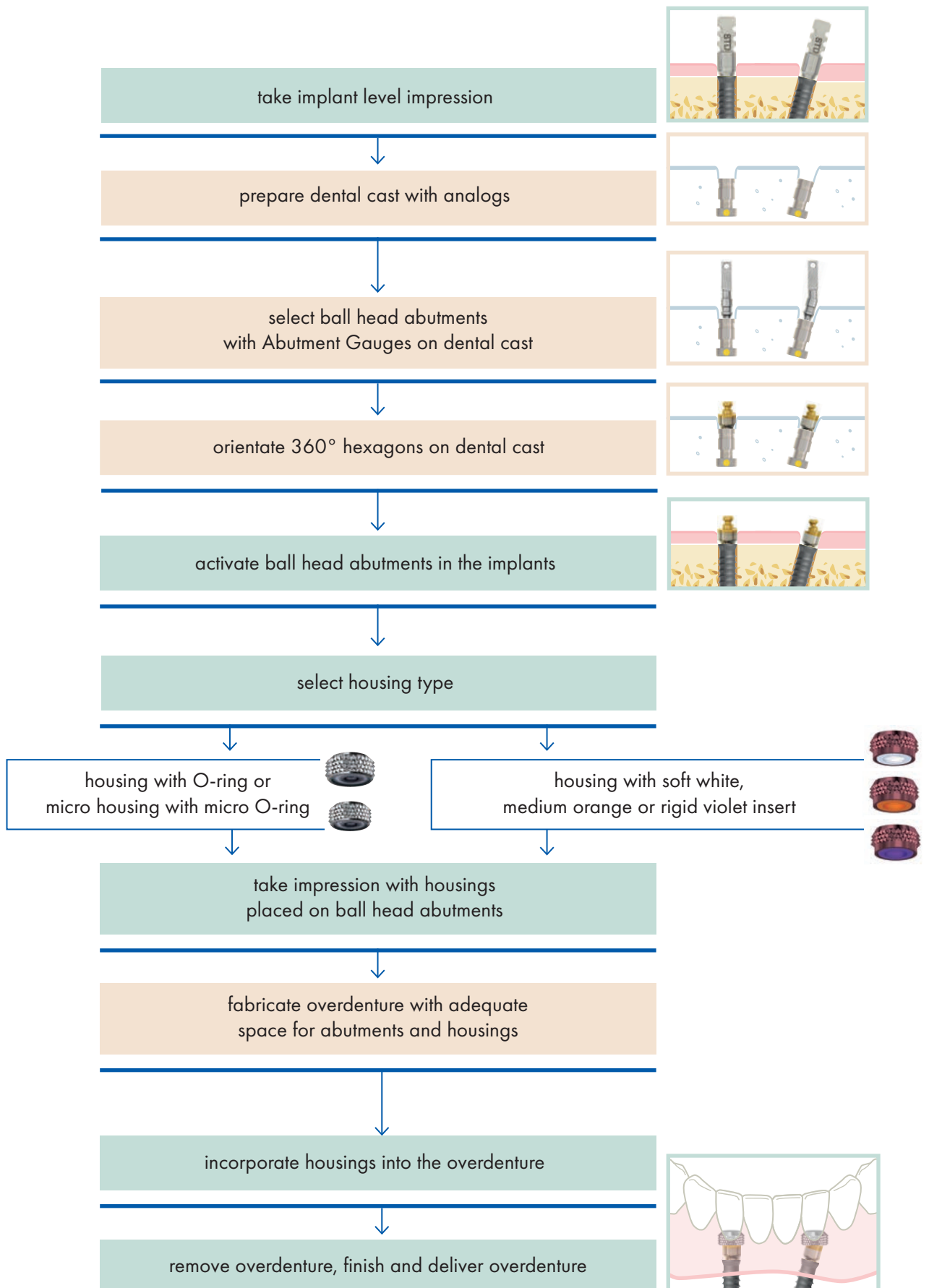

CONVENTIONAL PROSTHETIC WORKFLOW

REMOVABLE CONOMETRIC-RETAINED PROSTHESIS

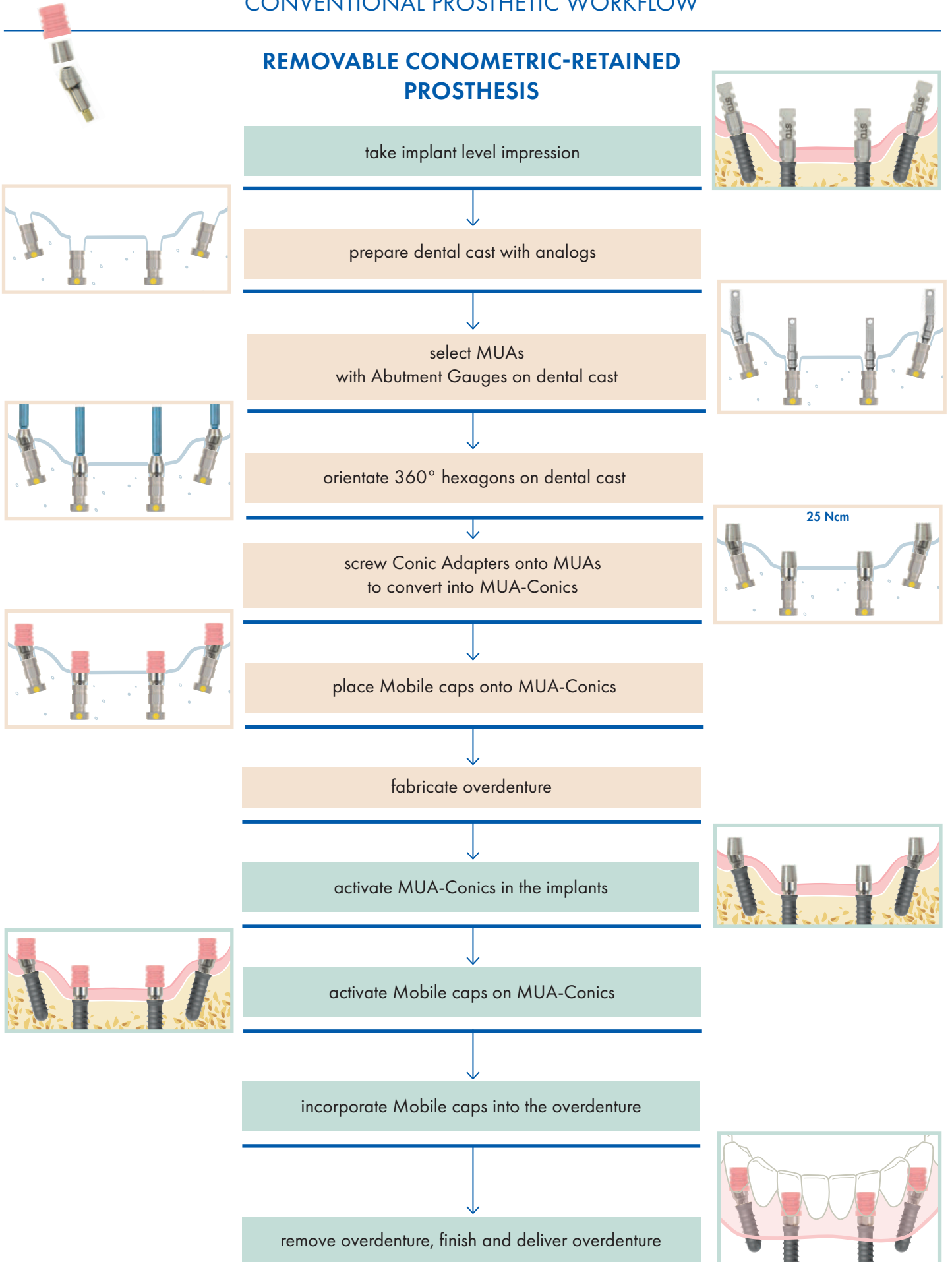

→ Steps carried out by **THE CLINICIAN**
→ Steps carried out by **THE DENTAL LABORATORY**

DIGITAL PROSTHETIC WORKFLOW

**CEMENT-RETAINED SINGLE CROWN**  
**CHAIRSIDE TECHNIQUE**



take digital intra-oral impression  
at implant level\*



select Ti-Base abutment\*\*  
design and mill the crown (CAD-CAM)

bond monolithic crown  
to Ti-Base abutment



activate restoration in the implant



\*Orientate the Scan Post so that the notch is on the buccal side.

\*\* As to dental CAD-CAM software including the specified products, please refer to Leone web site [www.leone.it](http://www.leone.it) under section *Implantology*.

DIGITAL PROSTHETIC WORKFLOW



**CEMENT-RETAINED SINGLE CROWN**  
**CONVENTIONAL IMPRESSION TAKING**

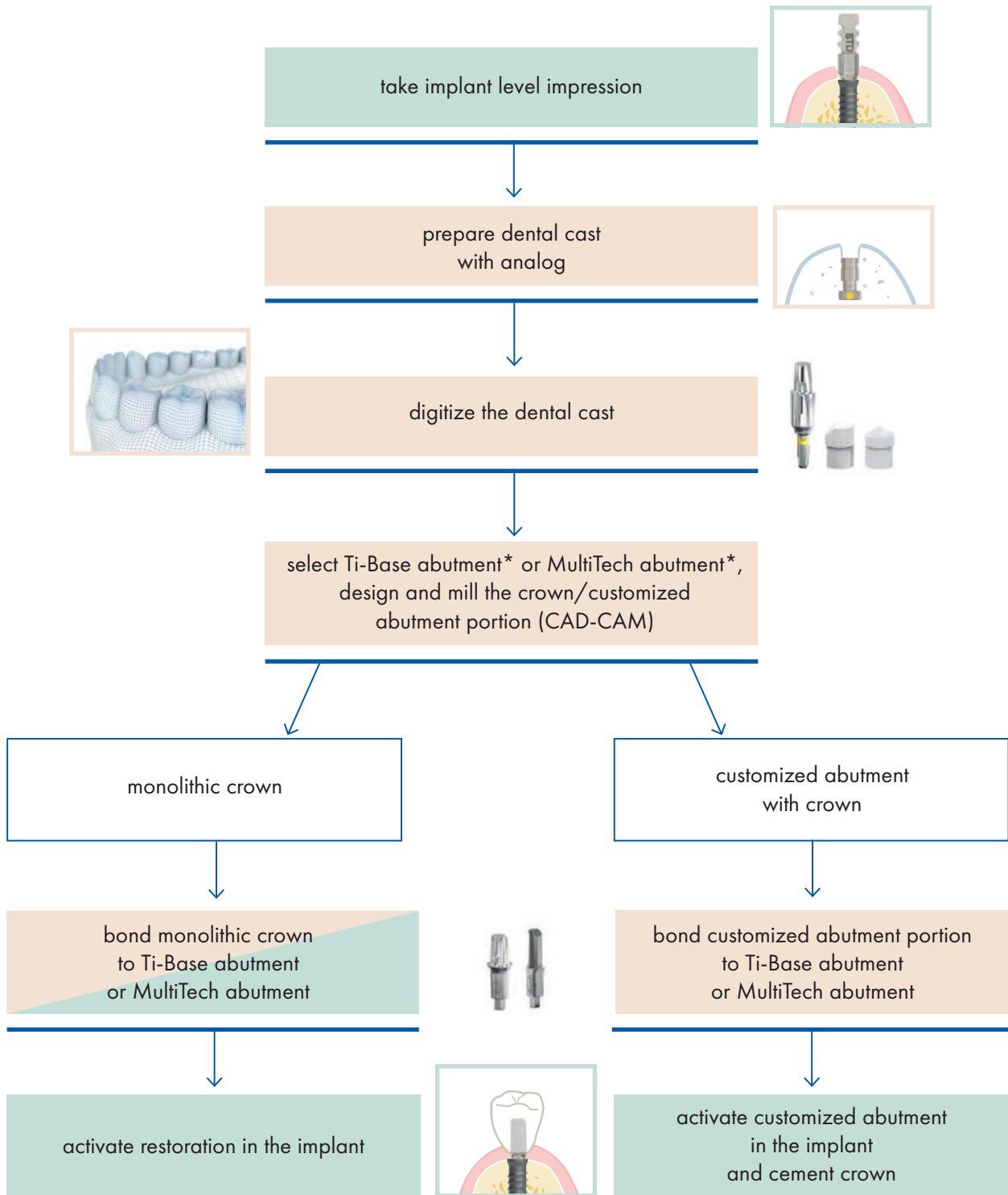

\*As to dental CAD-CAM software including the specified products, please refer to Leone web site [www.leone.it](http://www.leone.it) under section *Implantology*.

DIGITAL PROSTHETIC WORKFLOW

**CEMENT-RETAINED BRIDGE/SINGLE CROWN**

**CONVENTIONAL IMPRESSION TAKING**

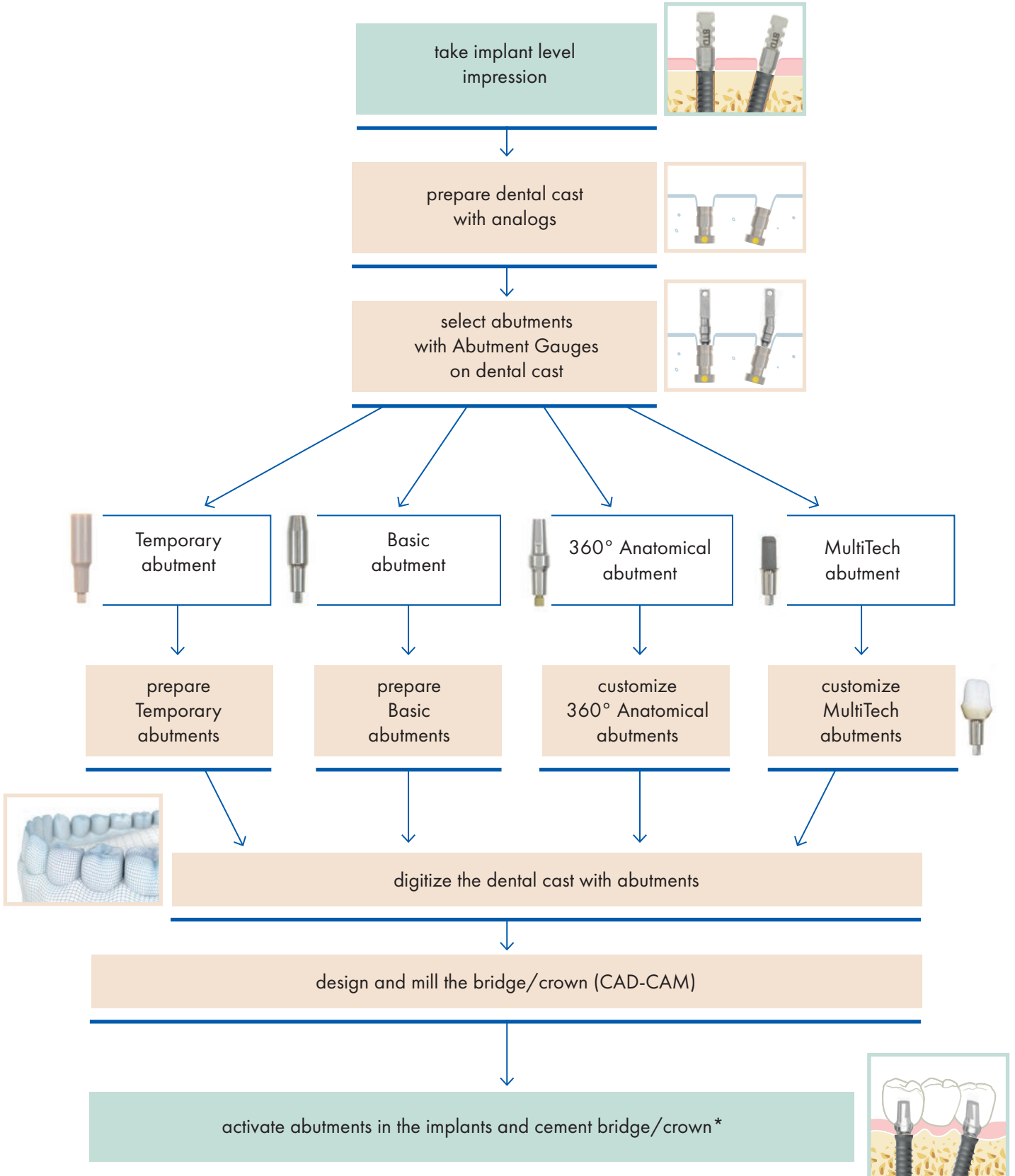

\*In case of single crowns, option: extra-oral cementation.

DIGITAL PROSTHETIC WORKFLOW

CEMENT-RETAINED BRIDGE/SINGLE CROWN

DIGITAL IMPRESSION TAKING

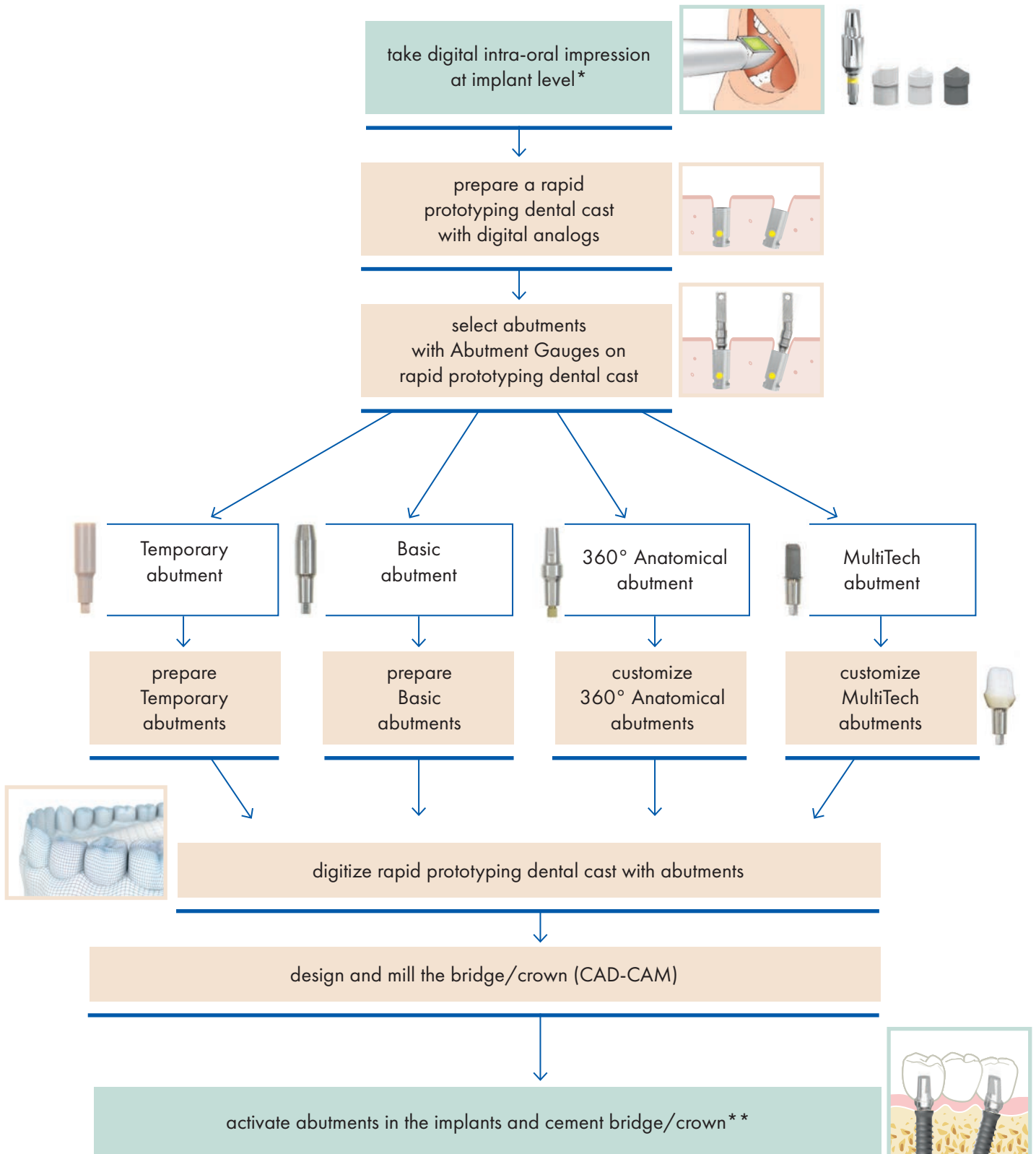

\* Orientate the Scan Post so that the notch is on the buccal side.

\*\*In case of single crowns, option: extra-oral cementation.



DIGITAL PROSTHETIC WORKFLOW



SCREW-RETAINED SINGLE CROWN - ABUTMENT LEVEL

CHAIRSIDE TECHNIQUE

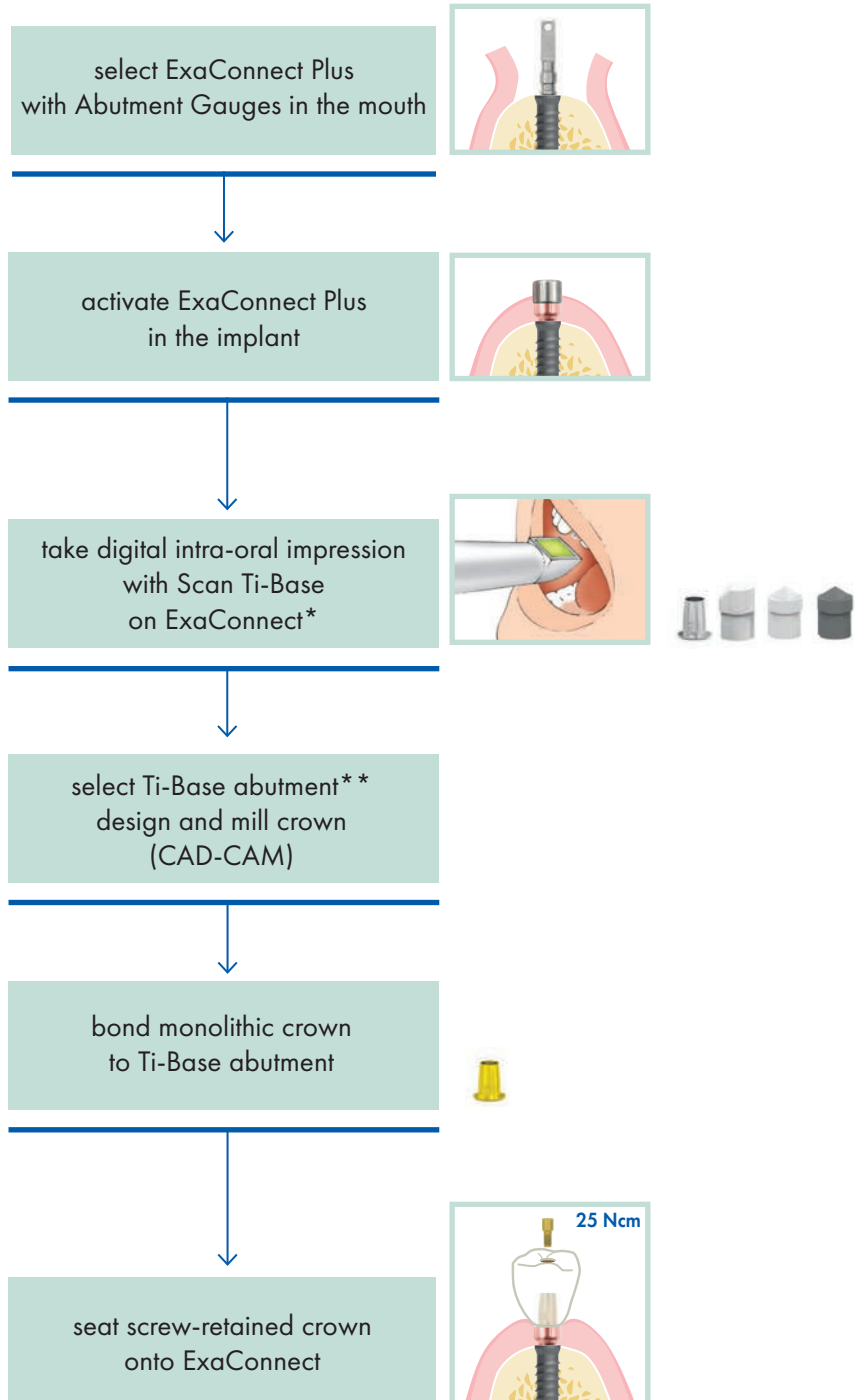

\* Orientate the Ti-Base abutment so that the notch is on the buccal side.

\*\* As to dental CAD-CAM software including the specified products, please refer to Leone web site [www.leone.it](http://www.leone.it) under section *Implantology*.

DIGITAL PROSTHETIC WORKFLOW



SCREW-RETAINED SINGLE CROWN - ABUTMENT LEVEL

CONVENTIONAL IMPRESSION TAKING

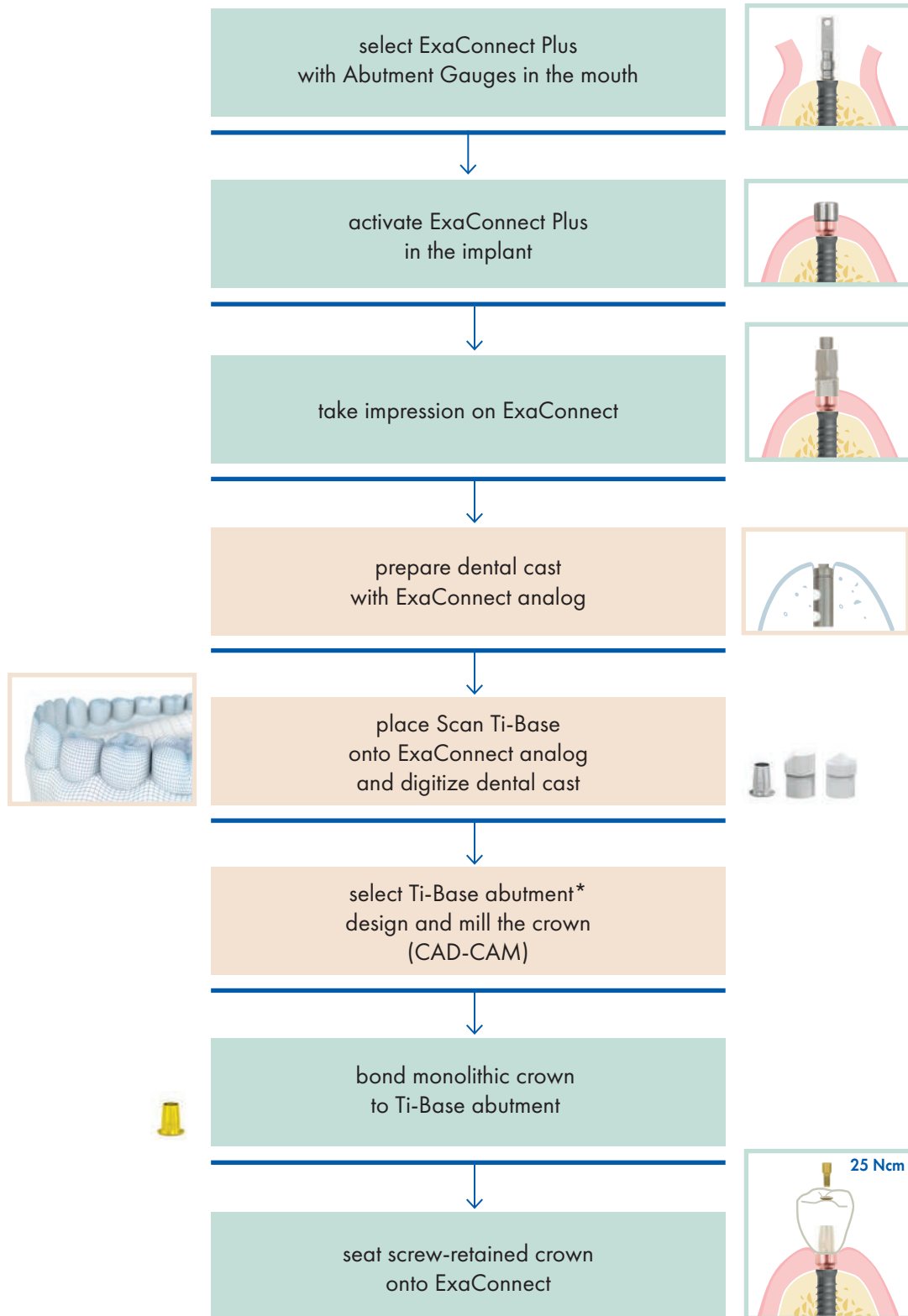

\*As to dental CAD-CAM software including the specified products, please refer to Leone web site [www.leone.it](http://www.leone.it) under section *Implantology*.

DIGITAL PROSTHETIC WORKFLOW

SCREW-RETAINED SINGLE CROWN - IMPLANT LEVEL

CONVENTIONAL IMPRESSION TAKING

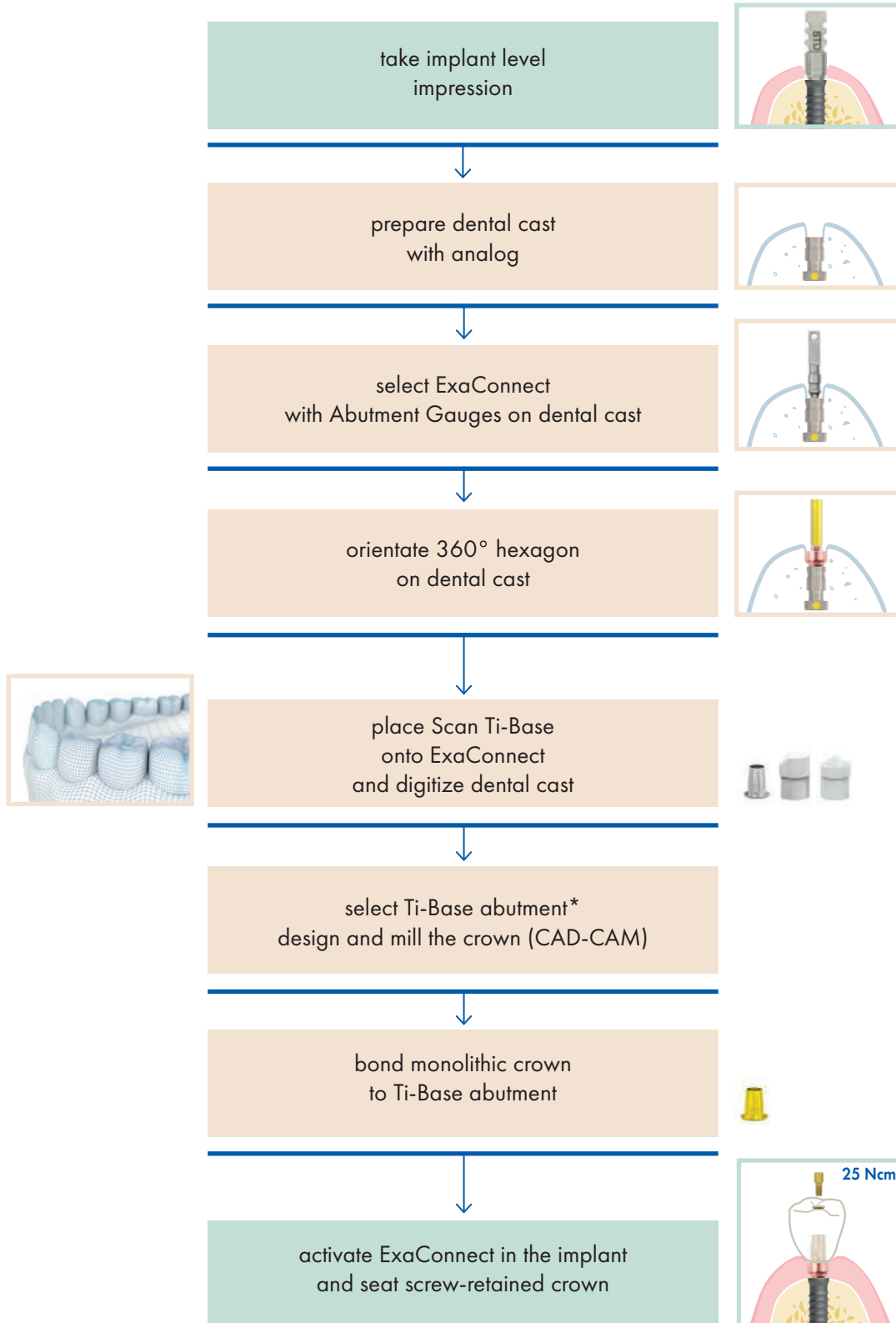

\*As to dental CAD-CAM software including the specified products, please refer to Leone web site [www.leone.it](http://www.leone.it) under section *Implantology*.

DIGITAL PROSTHETIC WORKFLOW



SCREW-RETAINED SINGLE CROWN - IMPLANT LEVEL

DIGITAL IMPRESSION TAKING

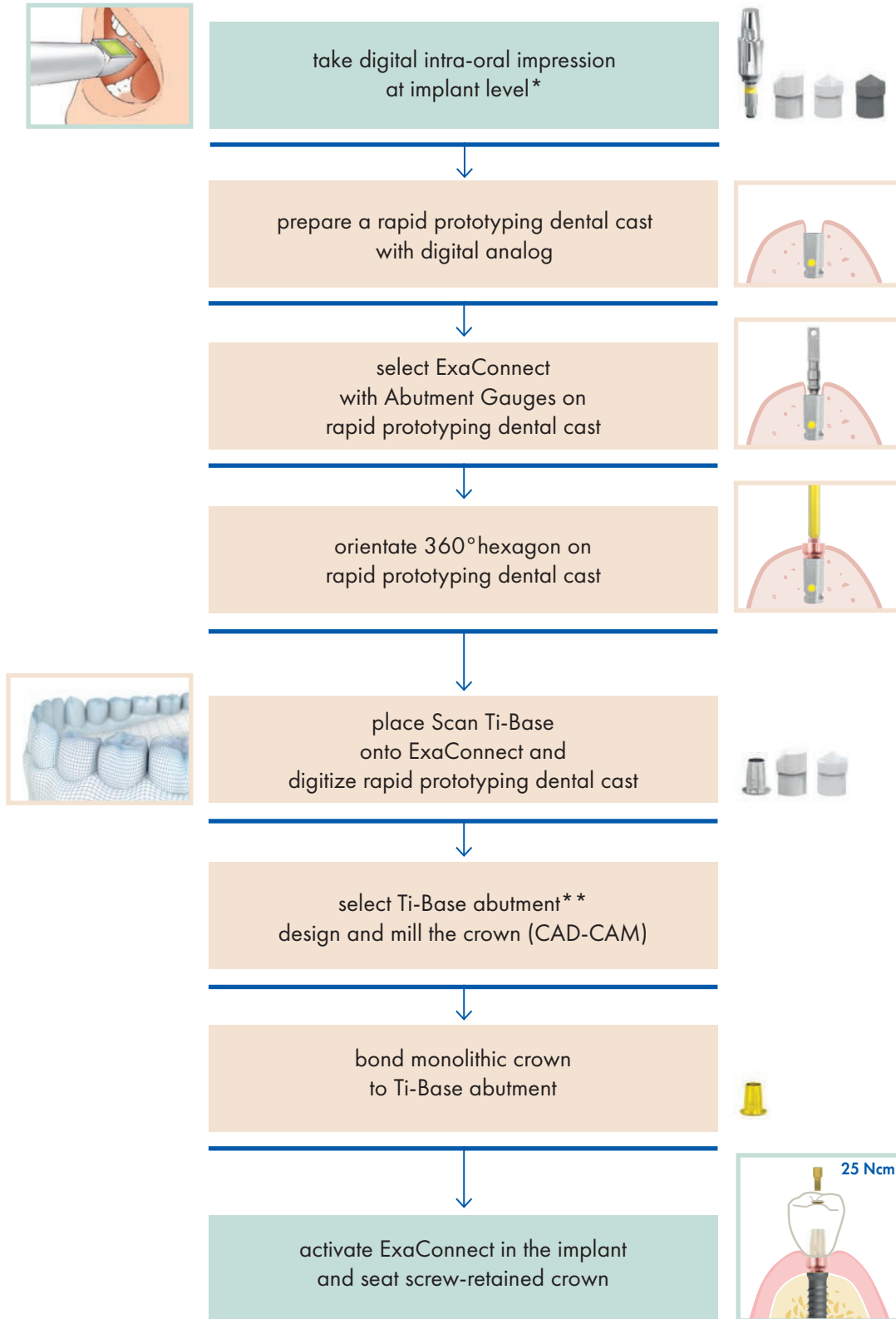

\*Orientate the Scan Post so that the notch is on the buccal side.

\*\* As to dental CAD-CAM software including the specified products, please refer to Leone web site [www.leone.it](http://www.leone.it) under section *Implantology*.

DIGITAL PROSTHETIC WORKFLOW

SCREW-RETAINED BRIDGE/BAR - IMPLANT LEVEL

CONVENTIONAL IMPRESSION TAKING

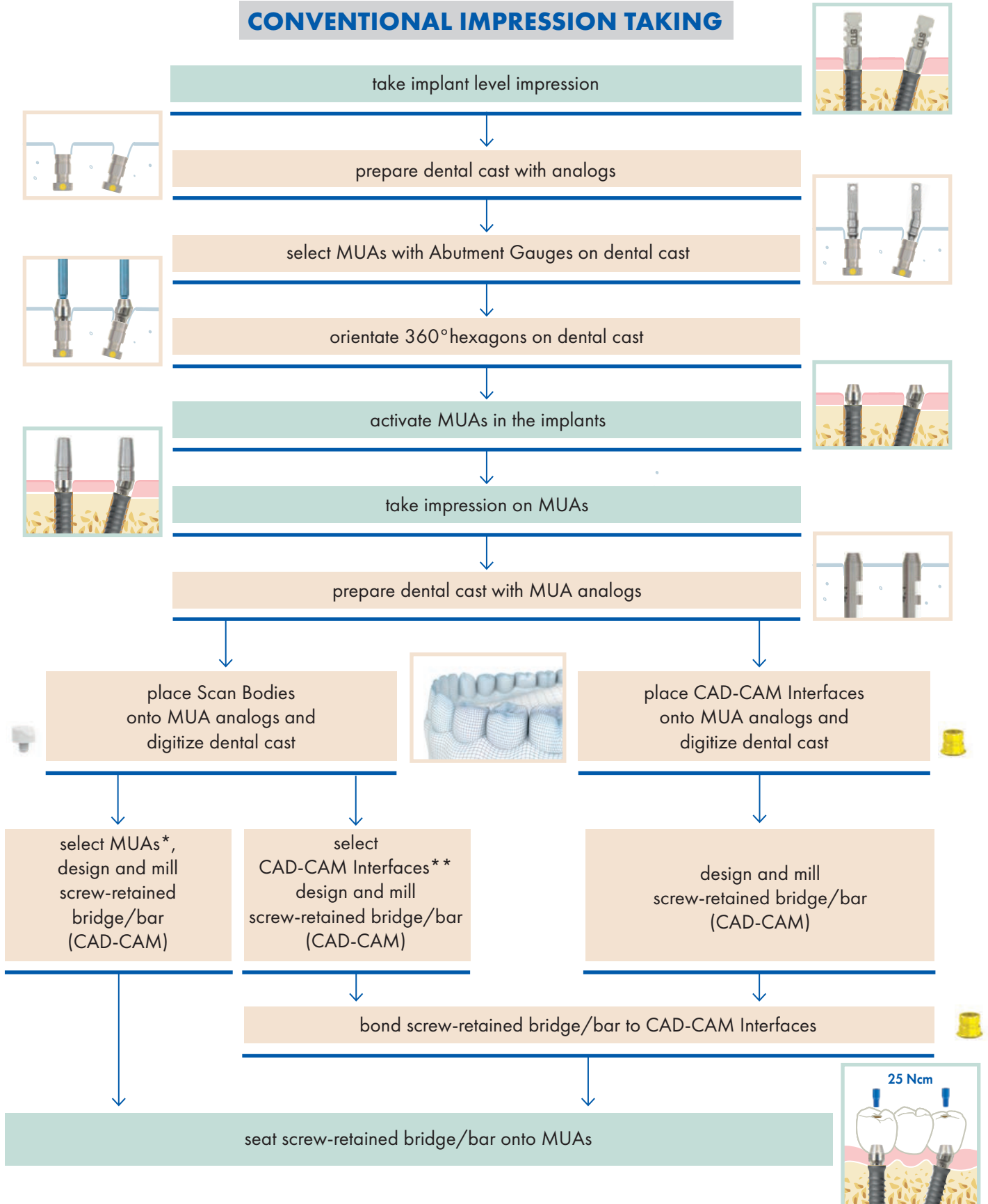

\* Make sure that STL files of MUAs are available in the milling center. Otherwise the milling center can contact us by sending an email to 3d@leone.it.  
 \*\* As to dental CAD-CAM software including the specified products, please refer to Leone web site [www.leone.it](http://www.leone.it) under section *Implantology*.

DIGITAL PROSTHETIC WORKFLOW



SCREW-RETAINED BRIDGE/BAR - ABUTMENT LEVEL

CONVENTIONAL IMPRESSION TAKING

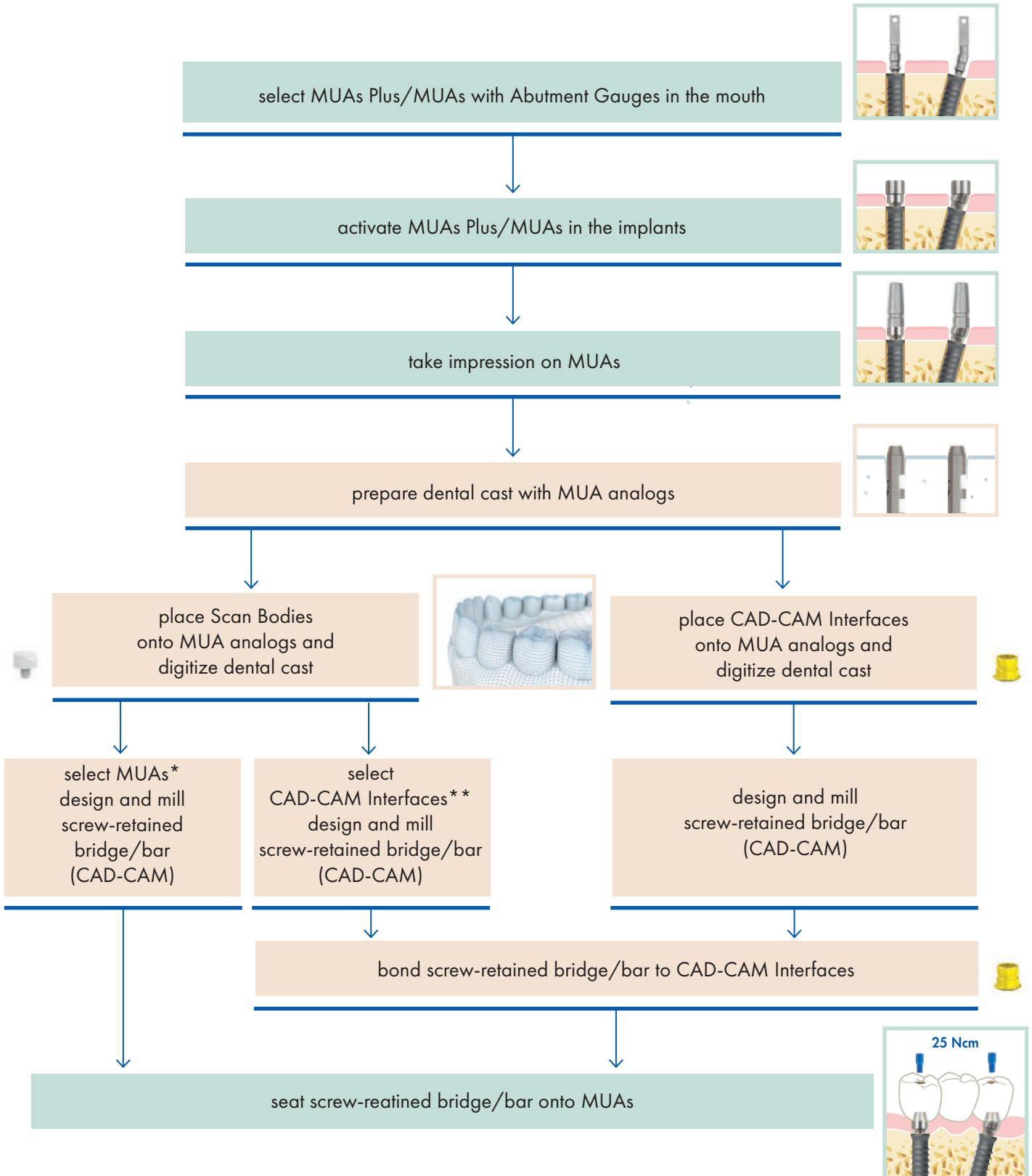

\* Make sure that STL files of MUAs are available in the milling center. Otherwise the milling center can contact us by sending an email to 3d@leone.it.

\*\* As to dental CAD-CAM software including the specified products, please refer to Leone web site [www.leone.it](http://www.leone.it) under section *Implantology*.

DIGITAL PROSTHETIC WORKFLOW

SCREW-RETAINED BRIDGE/BAR - ABUTMENT LEVEL

DIGITAL IMPRESSION TAKING

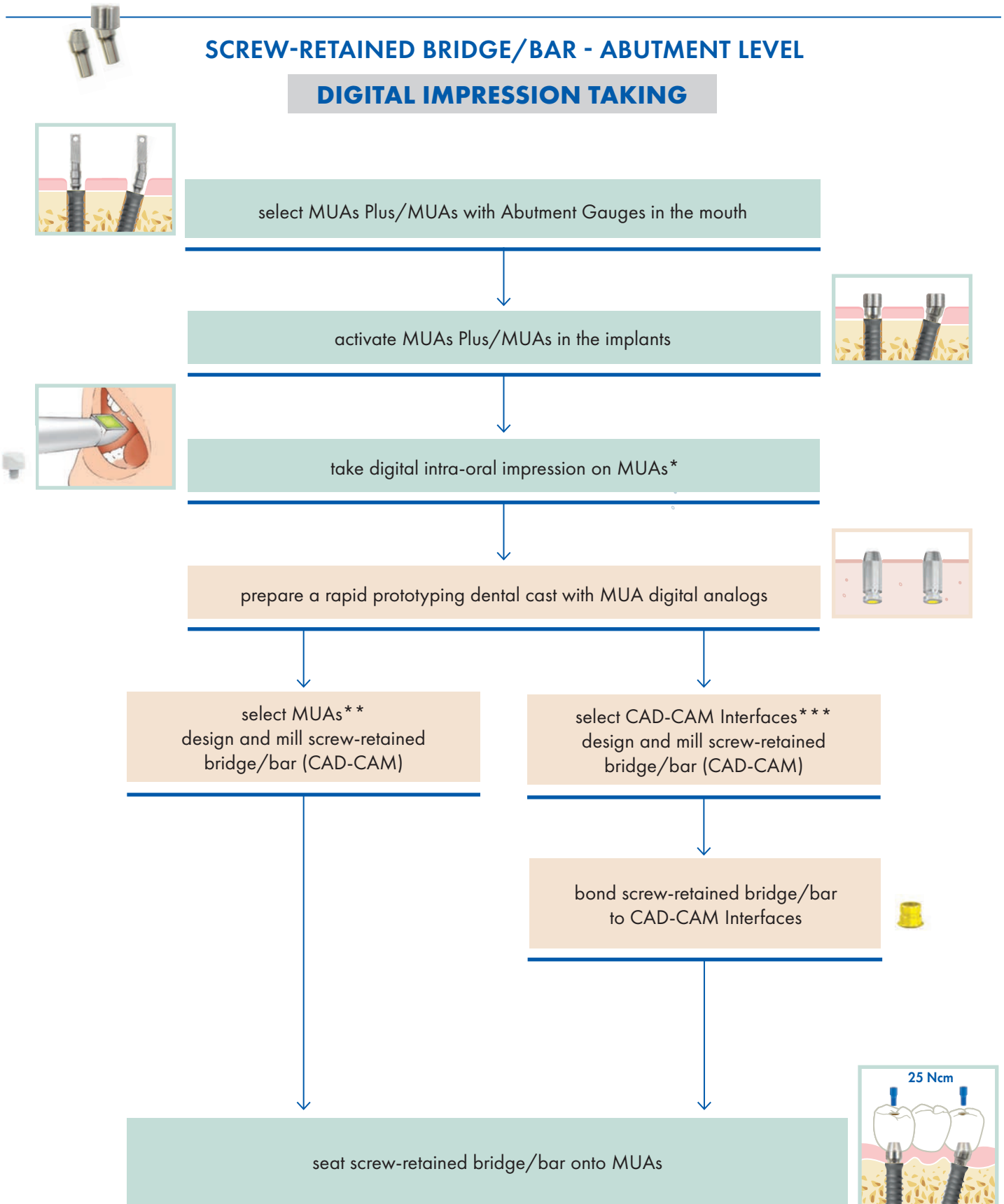

\* Make sure the intra-oral scanner is indicated for this procedure.

\*\* Make sure that STL files of MUAs are available in the milling center. Otherwise the milling center can contact us by sending an email to 3d@leone.it.

\*\*\* As to dental CAD-CAM software including the specified products, please refer to Leone web site [www.leone.it](http://www.leone.it) under section *Implantology*.

DIGITAL PROSTHETIC WORKFLOW

CONOMETRIC-RETAINED BRIDGE WITH FIXED CAPS

CONVENTIONAL IMPRESSION TAKING

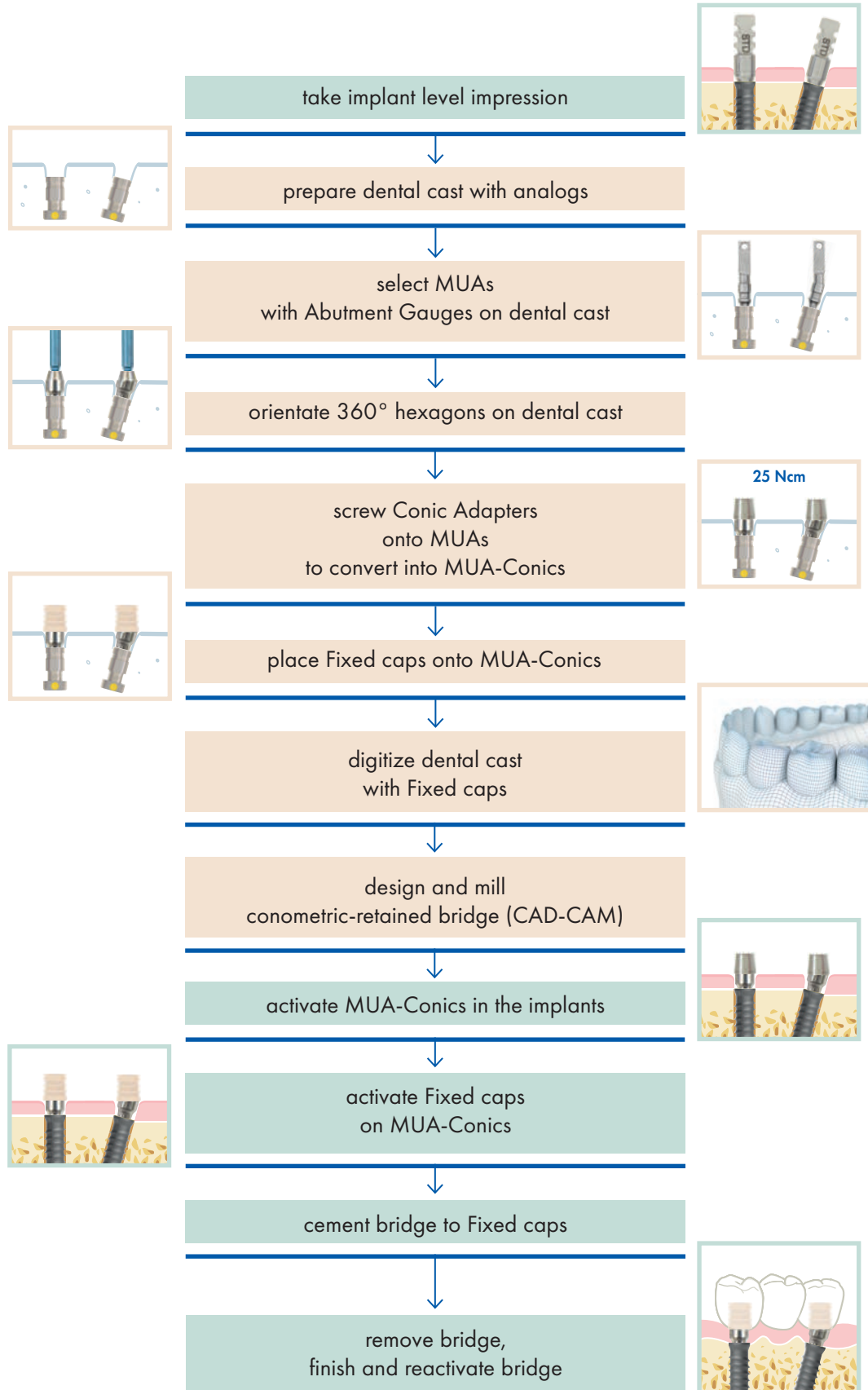

→ Steps carried out by THE CLINICIAN      → Steps carried out by THE DENTAL LABORATORY



DIGITAL PROSTHETIC WORKFLOW

CONOMETRIC-RETAINED BRIDGE WITH FIXED CAPS

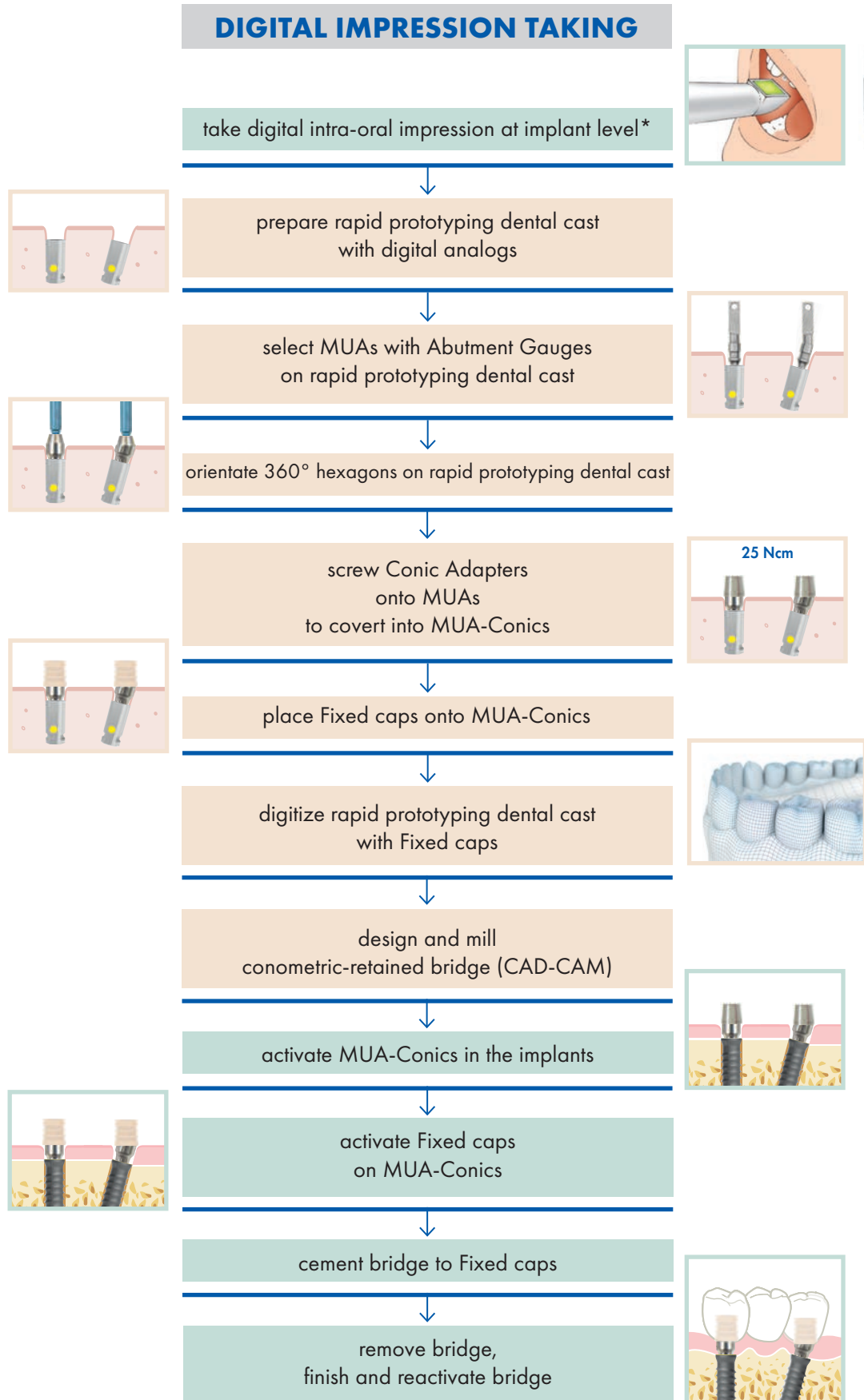

\*Orientate the Scan Post so that the notch is on the buccal side.



---

# MONOIMPLANTS FOR O-RING OVERDENTURE

## MONOIMPLANTS



### Ideal for

- overdenture stabilization in atrophic edentulous mandibles

### Features

- made of medical grade 5 titanium
- implant with integrated ball head
- smooth tapered neck
- cylindrical geometry of the endosseous portion
- atraumatic thread design (Standard ISO 5835)
- HRS surface (roughness  $R_a \approx 1 \text{ mm}$ )
- implant diameter of 2.7 mm
- 2 gingival heights (3 - 5 mm)
- 4 endosseous lengths (10 - 12 - 14 - 16 mm)

### Leone monoimplant: minimally invasive and strong



The Leone monoimplant has been developed for the stabilization of overdentures in the lower jaw on 4 monoimplants placed at the level of mandibular symphysis, in the area between the two foramina.

The reduced diameter of only 2.7 mm allows for easy and minimally invasive insertion even in severely resorbed atrophic mandibles. Its self-tapping design provides excellent primary stability.

Despite the small implant diameter, it features a torsional resistance greater than 140 Ncm. The reduced size of the micro-housing permits re-use of existing dentures.





## Monoimplants $\varnothing$ 2.7 mm gingival height 3 mm





$\varnothing$ (mm)	2.7	2.7	2.7	2.7
length (mm)	10	12	14	16
REF	<b>111-2710-13</b>	<b>111-2712-13</b>	<b>111-2714-13</b>	<b>111-2716-13</b>

## Monoimplants $\varnothing$ 2.7 mm gingival height 5 mm

$\varnothing$ (mm)	2.7	2.7	2.7	2.7
length (mm)	10	12	14	16
REF	<b>111-2710-15</b>	<b>111-2712-15</b>	<b>111-2714-15</b>	<b>111-2716-15</b>

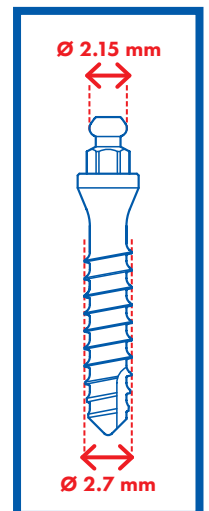

### Sterile package

- 1 monoimplant
- 1 micro housing with micro O-ring
- 1 spacer ring for monoimplant (white)
- 1 spacer ring for abutments (grey)

## HOUSING WITH O-RING

- made of medical grade 5 titanium
- O-ring pre-mounted inside
- retention force 10 N
- autoclavabile

### Pack content:

- 1 housing with O-ring
- 1 spacer ring for abutments

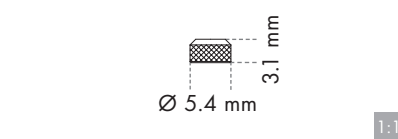

REF **123-0002-00**

## O-RING

- made of elastomer
- refill for housing with O-ring
- autoclavabile

### Pack of 10



2:1

REF **123-0001-00**

## MICRO HOUSING WITH MICRO O-RING

- made of medical grade 5 titanium
- micro O-ring pre-mounted inside
- retention force 10 N
- autoclavabile

### Pack content:

- 1 micro housing with micro O-ring
- 1 spacer ring for abutments (grey)
- 1 spacer ring for monoimplants (white)

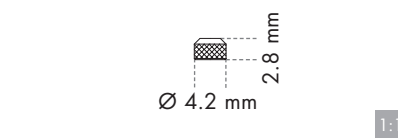

REF **123-0003-00**

## MICRO O-RING

- made of elastomer
- refill for micro housing with micro O-ring
- autoclavabile

### Pack of 10



2:1

REF **123-0001-01**

## ORGANIZER FOR MONOIMPLANTS FOR O-RING OVERDENTURE

- 151-2215-20 mucosa punch for handpiece Ø 2.7
- 151-1930-02 lance drill
- 151-2222-42 pilot drill, long Ø 2.2 mm
- 156-2002-00 depth gauge
- 156-2004-00 2 measuring pins for gingival height
- 156-1015-00 fan-type wrench for monoimplants
- 156-1017-00 handpiece adapter for monoimplants



REF **156-0017-00**

## MUCOSA PUNCH FOR CONTRA-ANGLE

- made of medical grade 5 titanium
- to punch the mucosa
- Ø 2.7 mm
- with marks at 3, 5 and 7 mm for the measurement of the gingival thickness
- autoclavable

**Pack of 1**



REF **151-2215-20**

## MEASURING PIN FOR GINGIVAL HEIGHT

- made of medical grade 5 titanium
- for measuring the height of soft tissues and parallelism of the implant sites
- Ø 2.2 mm
- with a hole for the placement of a safety leash
- autoclavable

**Pack of 1**



1:1

REF **156-2004-00**

## DEPTH GAUGE

- made of medical grade 5 titanium
- to verify the depth of the implant site
- Ø 2.2 mm
- with a hole for the placement of a safety leash
- autoclavable

**Pack of 1**



1:1

REF **156-2002-00**

## FAN-TYPE WRENCH FOR MONOIMPLANT

- made of stainless steel and anodized aluminium
- to complete the placement of the monoimplant
- with hex hole matching with the monoimplant head
- with a hole for the placement of a safety leash
- autoclavable

**Pack of 1**



REF **156-1015-00**

## RATCHET ADAPTER

- made of stainless steel
- allows the use of the ratchet for the placement of the monoimplant
- autoclavable

**Pack of 1**



REF **156-1016-00**

## HANDPIECE ADAPTER

- made of stainless steel
- allows the use of the handpiece for the placement of the monoimplant
- autoclavable

**Pack of 1**



REF **156-1017-00**

## TEMPLATE FOR MONOIMPLANT

To guide the clinician in the choice of the right monoimplant: technical drawings show monoimplants with 3 mm gingival height in 3 scales to match possible distortions created by the X-ray unit used for the radiographs:

- actual dimensions 1:1
- dimensions increased by 10%
- dimensions increased by 25%

**Pack of 1**

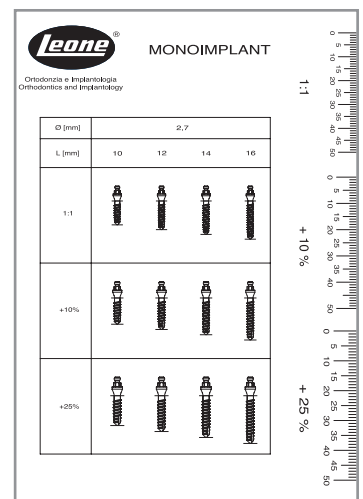

REF **156-2003-01**



---

# SURGICAL AND PROSTHETIC PROCEDURE

## FOR MONOIMPLANTS FOR O-RING OVERDENTURE



The pictures and illustrations in this brochure are for information purposes only and they are not intended to replace the methods or procedures for diagnosis and treatment planning of the Dental surgeon, Dentist and Dental Technician regarding the needs of each patient. Leone Spa disclaims any liability or any other obligation expressed or implied in this brochure.

## DISCLAIMER

---

**The Surgical and Prosthetic Procedures related to the use of the Leone products for Monoimplants for O-ring overdenture described in the following pages are intended for Professionals experienced in dental implant techniques.**

In case of lack of basic notions, we suggest to attend specific courses in order to reach a high level of knowledge and practice in the use of implants. The instructions for use of the products described below represent a sort of standard instructions that have to be adjusted to the individual needs and to the particular situations that may occur on the basis of the manual ability, the experience and diagnosis effected by the legally qualified medical operator. It is not ascribed to the manufacturer the duty of monitoring the procedures of use of the product. A correct and appropriate use of the instruments and products related to the LEONE Monoimplants for O-ring overdenture shall completely be reverted to the clinician. The surgical procedure hereunder described is merely indicative as any single treatment case is assigned to the experience of the operator. As every medical operator well knows, a correct procedure and a perfect manufacture of the prosthesis may sometimes be followed by not satisfactory results owing to particular situations not imputable to responsibility of the dental operator or the manufacturer.

## TREATMENT PLANNING

---

### Indications

The Leone Monoimplant for O-ring overdenture therapy is indicated in the treatment of the TOTAL LOWER EDENTULISM.

### Contraindications

For contraindications and side effects read the instructions for use enclosed in the package of each product and available in our web site [www.leone.it](http://www.leone.it) in the section Services/Quality.

## PREOPERATIVE EXAMS

---

Before starting the surgical intervention, the patients have to be subjected to a series of exams; any single case has to be evaluated by the clinician.

### Anamnesis

It is the first approach to the patient and it represents a fundamental tool to recognize both risk factors and contraindications. Moreover, anamnesis allows for the evaluation of patient's expectations, priorities, degree of compliance and motivation.

Anamnesis can help in evaluating the need for extra exams in addition to the routine ones (when the presence of pathologies that were not reported by the patient is suspected) and when particular situations drive to deem a complete medico-surgical exam may be necessary.

### Objective exam

It consists of:

- inspection of the periodontal tissues, of the oral mucosa and of the teeth along with an initial evaluation of the occlusal relationships (skeletal Class, characteristics of the opposing arch and related potential problems, type of occlusion, interarch distance), of the presence of parafunctions, of the degree of oral hygiene, of the aesthetic conditions, of the morphology of the edentulous crest and the space available for the replacement of the prosthesis.
- palpation of the soft tissues and implant sites for a preliminary evaluation of the bone morphology and thickness.
- a complete periodontal probing for the appraisal of the absence of both gingivitis and pockets.

## Radiographic exams

**PANORAMIC RADIOGRAPH:** frequently, this radiograph allows an appraisal of the bone height and the relationships between implant site and adjacent structures, such as mandibular canal, etc.

It is also possible to identify concavities and ossification defects due to previous tooth extractions.

**INTRAORAL RADIOGRAPH:** it is very helpful for the determination of the apico-coronal availability of bone.

**LATERAL CEPHALOGRAM:** it is useful for the determination of the mandibular symphysis.

**COMPUTERIZED TOMOGRAPHY:** it is advisable to remind that previous radiographic exams provide two-dimensional images which do not give information on bone thickness. In order to obtain this useful information a computerized tomography is necessary: it provides three-dimensional images, thus allowing for an accurate evaluation of bone morphology and, sometimes, bone density.

## Instrumental or laboratory exams

When necessary, in cases where a pathology is suspected on the basis of anamnesis or clinical records.

## MONOIMPLANT SELECTION

---

The dimensions (implant length and transmucosal neck height) of the monoimplants to be seated are determined by the following factors:

1. amount of bone available
2. characteristics of the implant site
3. thickness of the soft tissues in the areas involved.

Further and particular individual situations must be evaluated by the Dentist or the Dental Surgeon.

Do not place monoimplants in the upper arch.

A template is available that shows all Leone monoimplants GH3 in actual dimensions, with dimensions increased by 10% and increased by 25%, to match possible distortions created by the X-ray unit used for the images (CBCT, panoramic radiograph, standard and digital cephalograms). To determine the distortion created by the X-ray unit you may use a sphere with a known diameter during X-ray exam. Superimpose the template to the radiograph in order to select the monoimplant in relation to the quantity of bone available.

To simplify the surgical operation, an organizer for monoimplants is available to sterilize and hold on the surgical field the necessary instruments.

**LEONE SURGICAL INSTRUMENTS ARE SUPPLIED NON-STERILE: CLEANING, DISINFECTION AND STERILIZATION AFTER REMOVAL FROM THE PACKAGE AND PRIOR TO EACH FURTHER USE ARE REQUIRED. CONSULT THE "Instructions for instrument sterilization" AVAILABLE FOR DOWNLOAD AT [www.leone.it](http://www.leone.it) IN THE SECTION Services/Quality.**

## Interactions between dental implant and medical imaging techniques

Titanium dental implants hardly are not magnetic and are not heated during a Magnetic Resonance Imaging (MRI) and the artifacts on the bioimage are usually attributable to the implant-prosthetic device. For further details please refer to the document "Interactions between Leone orthodontic and implantology devices and medical imaging techniques" available for download at [www.leone.it](http://www.leone.it) in the section **Services/Quality**.

## 1. PREPARATION OF THE IMPLANT SITE

The access to the surgical site shall be selected by the professional according to the clinical-morphological parameters. Schematically and with illustrative purpose only, the following steps for the preparation of the implant site are illustrated.

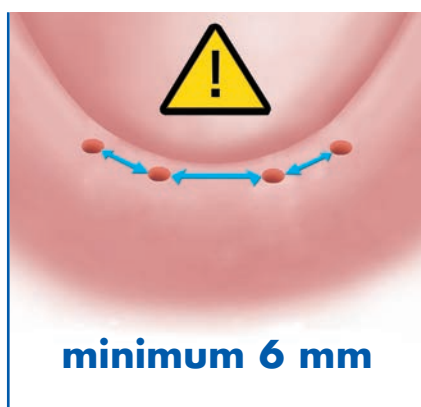

1.1 After adequate treatment planning, clearly mark the locations where the monoimplants must be inserted with a marker pen or a surgical template.

The Leone monoimplants must only be inserted in the mandible, at the level of the mandibular symphysis, located in the area between the two foramina.

The number of monoimplants required to adequately support a removable prosthesis is 4. The minimum required space between each implant and the next is 6 mm. This will allow the correct positioning of the micro housings.

The inclination of every single implant shall not exceed 8° to the axis of parallelism.

Make sure that the prosthesis is tissue borne and only implant retained. Avoid any implant-prosthetic load on the monoimplants since they are strictly a retentive element.

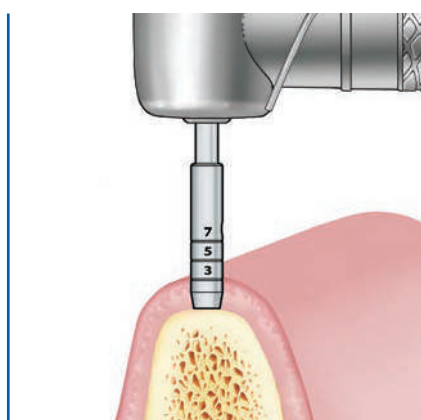

### 1.2a Flapless procedure

Punch the mucosa with the use of the special Ø 2.7 mucotome for handpiece. Use the mucotome with the micromotor set to a low speed (approx. 40 rpm). Use until bony tissue is met. On the mucotome there are three reference lines, at the heights of 3-5-7 mm starting from the crestal bone and acting as a reference for the measurement of the gingival height.

Remove the mucosa punch and the tissue plug by using a small periosteal elevator.

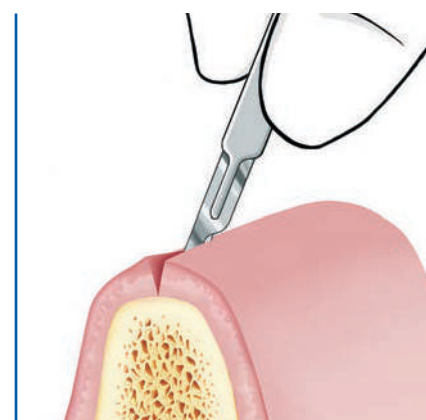
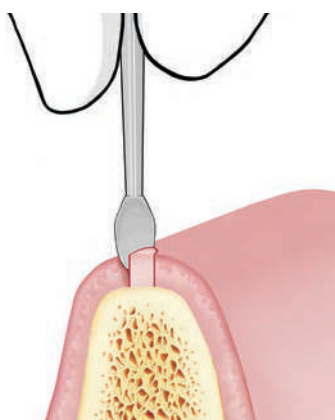

### 1.2b Flapping procedure

In case there are uncertainties on the condition of the crestal bone or the quantity of bone available, the use of a gingival flap procedure is advisable. Start with a scalpel incision of the soft tissues, then open the gingival flap for a clearer vision of the crestal bone: the osteotomy can now be performed.

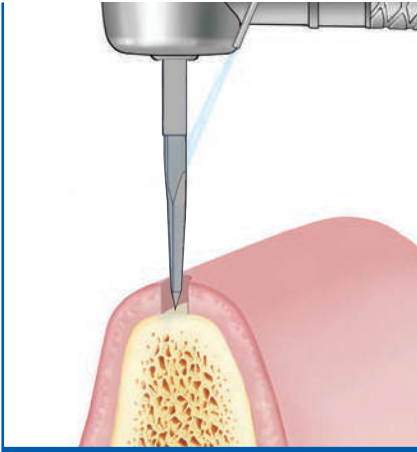

1.3 Once the gingival tunnel has been performed, use the round bur or lance drill to mark the cortical bone for the pilot drill.

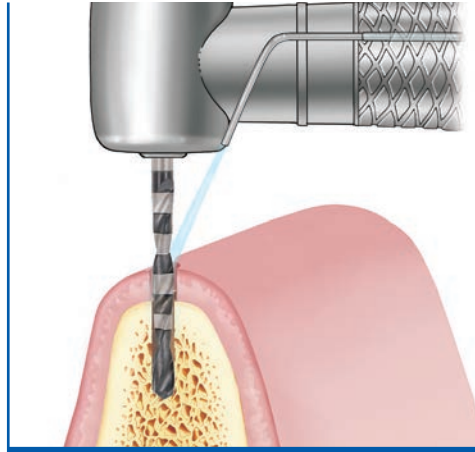

1.4 Insert the long pilot drill  $\varnothing$  2.2 mm into the hole and drill the bone until the length of the desired monoimplant has been reached (max. speed of 800 rpm with adequate irrigation). The drilling depth is clearly indicated by black DLC (Diamond-Like Carbon) coated depth marks on the drill. Pay attention to the length of the monoimplant, to which the height of the soft tissues has to be added.

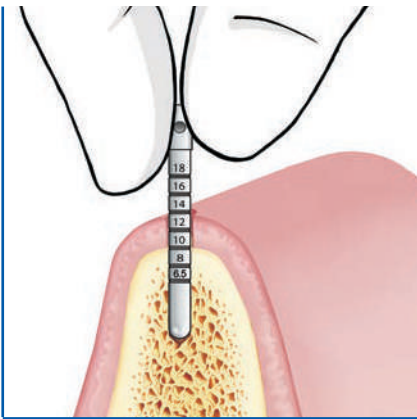

1.5 Insert the depth gauge into the newly created implant site to check its depth, considering also the height of soft tissues.

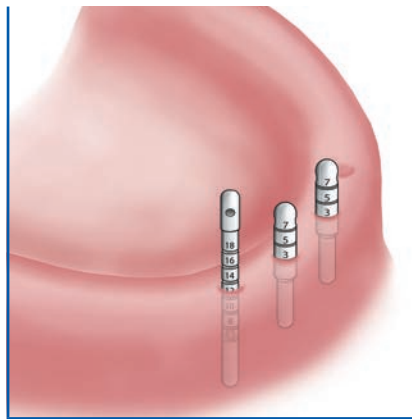

1.6 Repeat points 1.2 - 1.5 for the other three monoimplants, ensuring the maximum degree of parallelism among the surgical sites. Check the parallelism of the monoimplants using the measuring pins for gingival height and the depth gauge. The measuring pins may also be used at any other time to check soft tissue thickness.

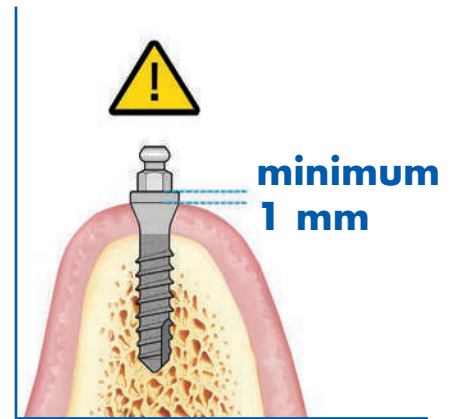

1.7 Choose the transmucosal neck height of the monoimplant. The head of the monoimplant must protrude from the gingiva by at least 1 mm to avoid a possible impingement of the micro housing on the patient's soft tissues.

## 2. MONOIMPLANT PACKAGING

The monoimplant is supplied with the micro housing in a sealed envelope that also carries the relevant product information. The packaging features a double protection to preserve the sterility of the implant subjected to a certified gamma X-ray process. Part of the label showing the information of the implant is removable for the "Implant Card" or the clinical case sheet of the patient. A sterility indicator is present on the glass vial.

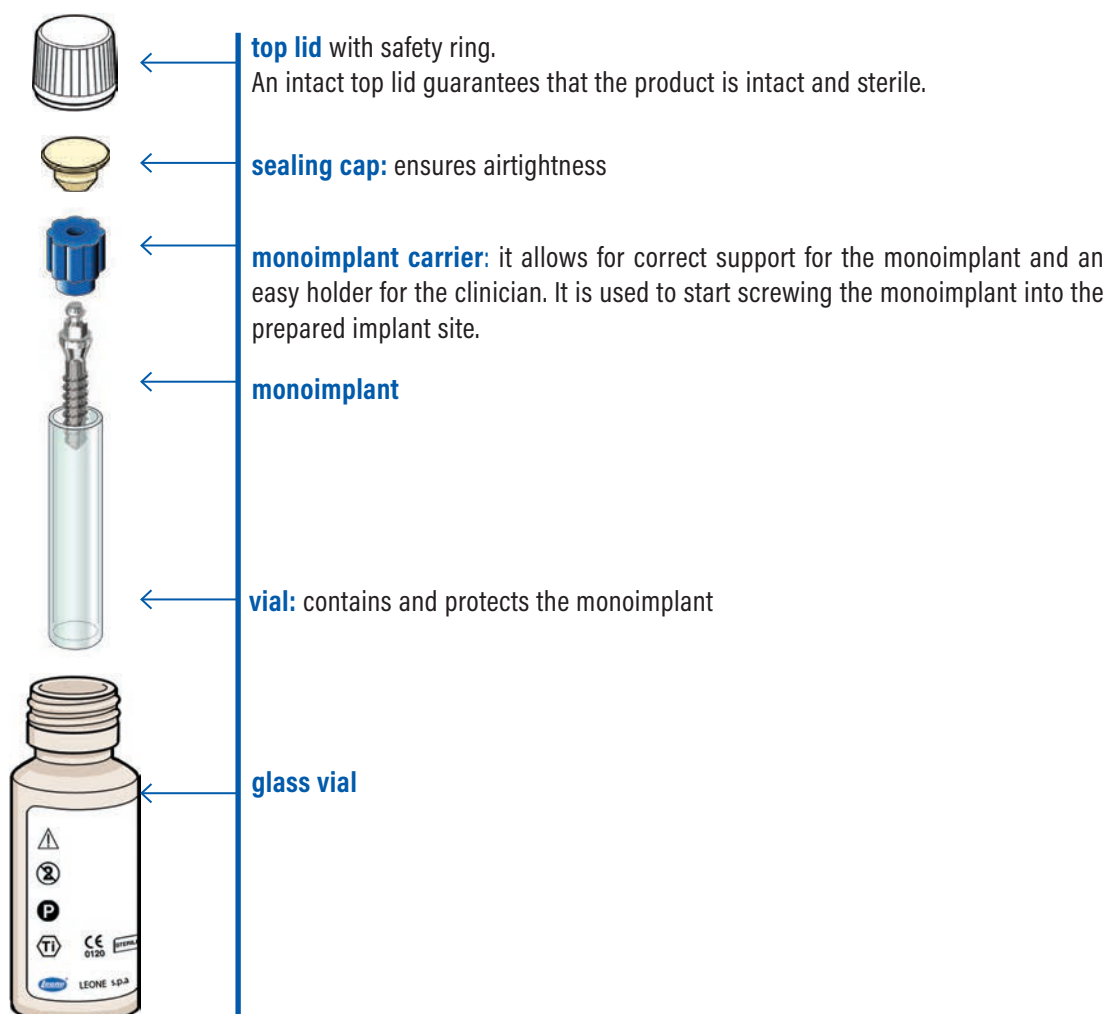



### 3. INSERTION OF THE MONOIMPLANT

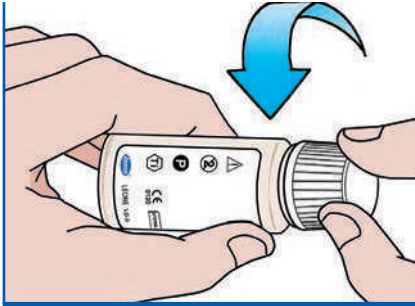

3.1 Unscrew the glass vial's top lid.

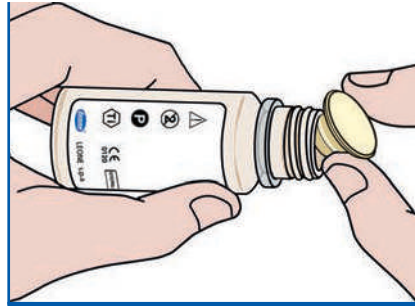

3.2 Remove the sealing cap.

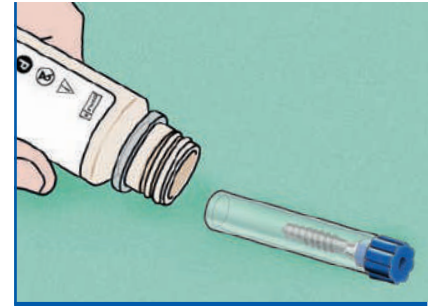

3.3 Extract the vial containing the monoimplant from the glass vial then lay it gently onto the sterile pad.

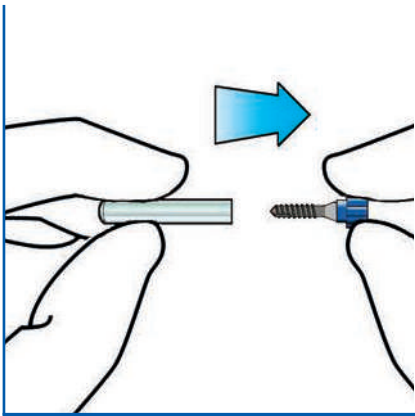

3.4 Hold the vial with one hand while gently pulling out the monoimplant with the other. Hold the monoimplant by the monoimplant carrier.

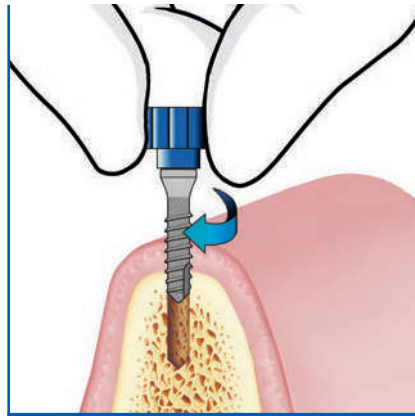

3.5 Still holding the monoimplant by the monoimplant carrier, insert it into the implant site with clockwise movement, while exerting a light downward pressure. Leone monoimplants are self-tapping.

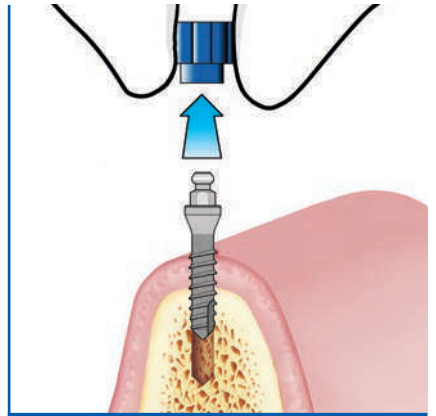

3.6 Remove the monoimplant carrier by pulling up.

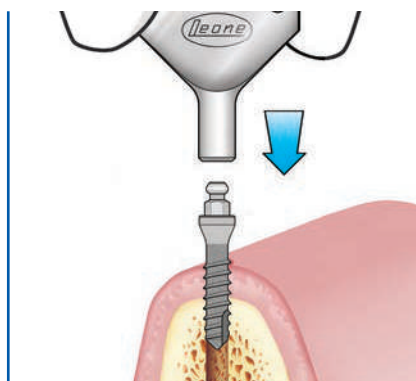

3.7 Position the fan-type wrench onto the head of the monoimplant. The wrench has a hole sideways for the insertion of a safety leash.

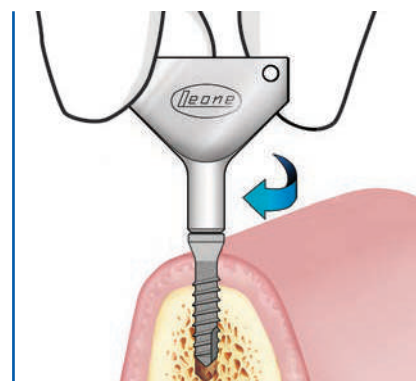

3.8a Screw the monoimplant in with a clockwise motion, until insertion is complete.

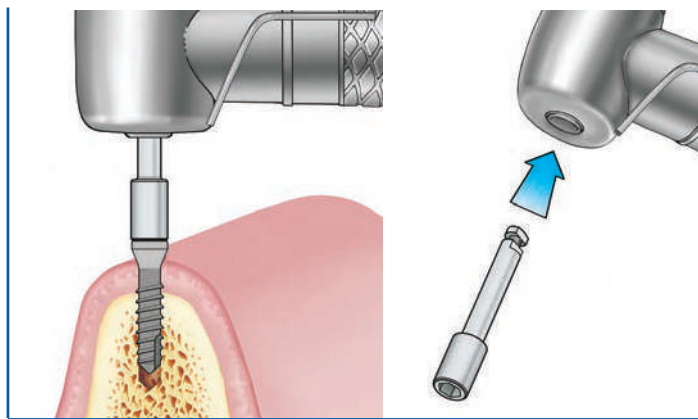

3.8b Alternatively, the monoimplant may be inserted with a contra-angle handpiece, using the contra-angle adapter. Set a micromotor's maximum speed to 20 rpm and a maximum torque value to 50 Ncm.

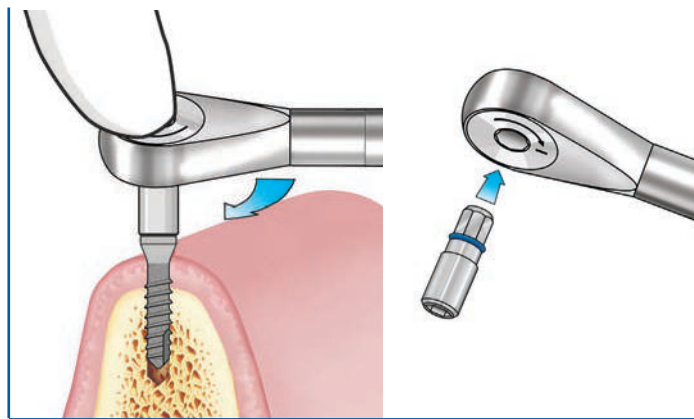

3.9 In case of particularly hard bone, the monoimplant can be inserted with the ratchet, using the specific adapter.

*N.B.: Should a ratchet be used to complete the insertion, it is recommended that the clinician should lightly press the head of the instrument with a finger during action, to keep the head perpendicular with the implant.*

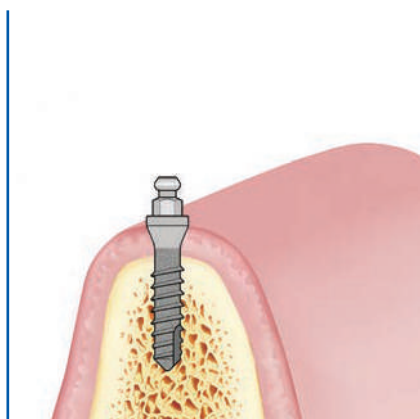

3.10 Once the monoimplant is in place, the base of the tapered section of the head should sit level with the crestal bone, while the head should stick out of the gum.

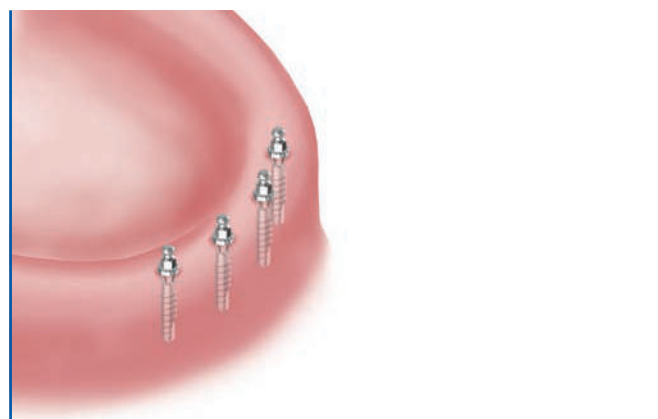

3.11 Repeat steps 3.1 - 3.10 for the remaining three monoimplants. Should a flapping technique be used, suture soft tissues around the monoimplants and load implants after healing has taken place. In the meantime relieve the existing prosthesis around the spherical heads of the monoimplants and fill the holes with soft acrylic.



## 4. PREPARATION OF THE REMOVABLE PROSTHESIS

During relining of the pre-existing prosthesis or manufacture of a new one, provide a wide tissue support for the prosthesis. Particular care must be taken to ensure complete tissue support of the prosthesis during the subsequent periodic checks, relining, as needed.

**CAUTION:** it is recommended to deliver the final prosthesis in the initial phase without housings to allow for adequate tissue adaptation and to correct possible impingements. The clinician will determine the length of the adaptation period.



4.1 Once the prosthesis is ready apply some soft wax on the inside surface of the prosthesis or dab the spherical heads of the monoimplants with a marker pen to reveal their location in the prosthesis.



4.2 Using the marks thus obtained in the prosthesis as reference, hollow out the areas needed to adequate diameter to receive the micro housings.

*CAUTION: if you are not sure whether the monoimplants have achieved adequate primary stability, we recommend relining the prosthesis with soft acrylic and waiting for a minimum of 3 months for osseointegration before incorporating the housings into the prosthesis.*

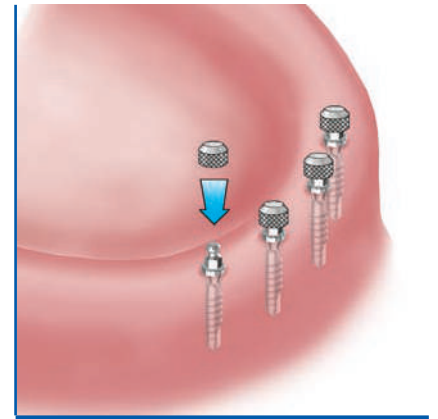

4.3 Place the micro housings on the spherical heads of the implants then press down until seated. Slight lack of parallelism can be overcome by using the housings instead of the micro housings.

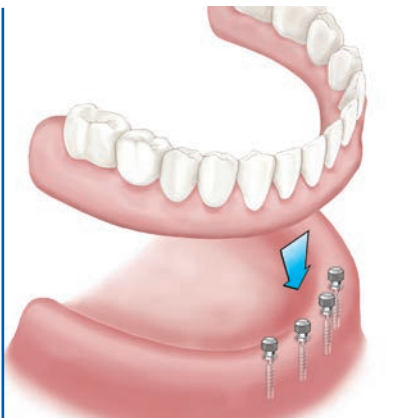

4.4 Insert the prosthesis in the patient's mouth for the final check. It should be free from friction and unwanted contacts. The prosthesis may be relieved corresponding to the micro housings in order to obtain a perfect tissue borne prosthesis without any friction on the housings.

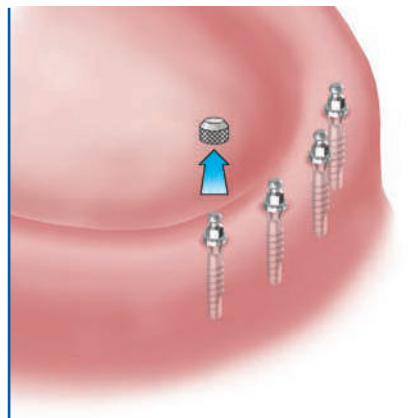

4.5 Remove the prosthesis and micro housings from the implants.

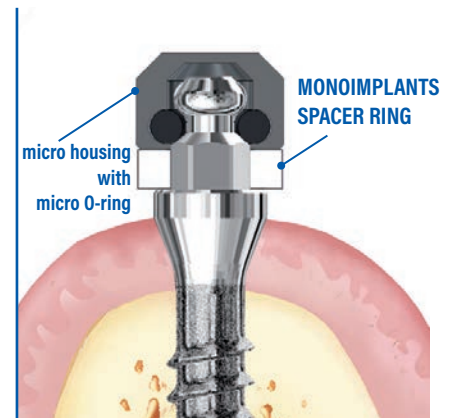

4.6 Place the white spacer ring over the monoimplant. This spacer ring is used to correctly position the micro housing, or the standard housing, into the prosthesis and minimize acrylic seeping into the undercuts of the spherical heads of the monoimplants.

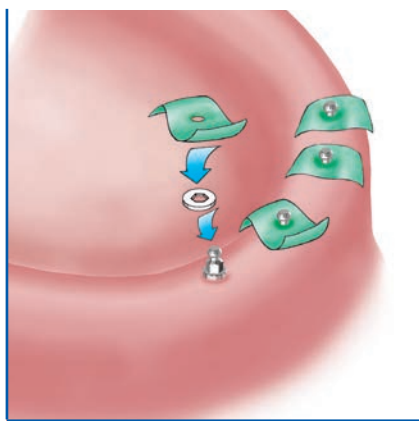

4.7 Place squared pieces of rubber dam over each monoimplant to avoid a direct contact between the soft tissue and the acrylic.

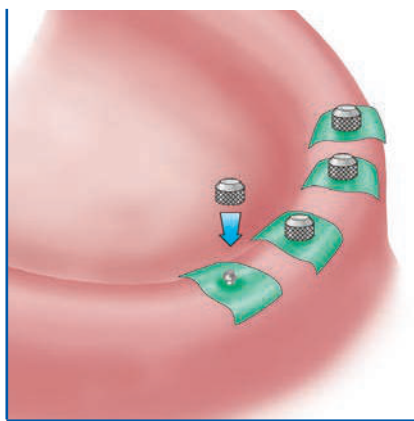

4.8 Place the micro housings onto the monoimplants. Please remember that all housings should be incorporated into the prosthesis at the same time. Do not attempt to place them individually.

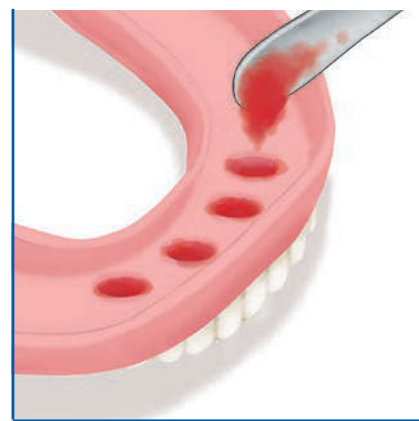

4.9 Fill the 4 cavities in the prosthesis with self-curing acrylic and also on the micro housings.

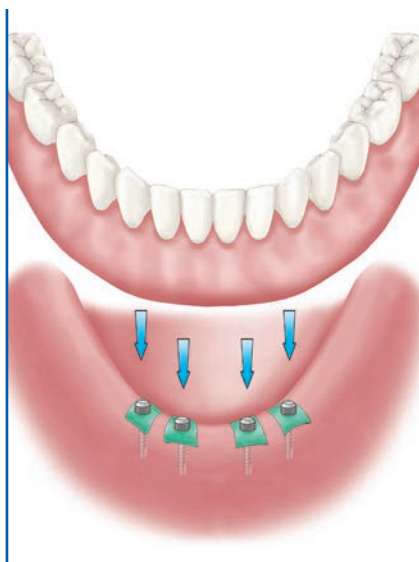

4.10 Fit the prosthesis in the mouth of the patient looking for adequate occlusal contact. The patient should not close the mouth too tightly.

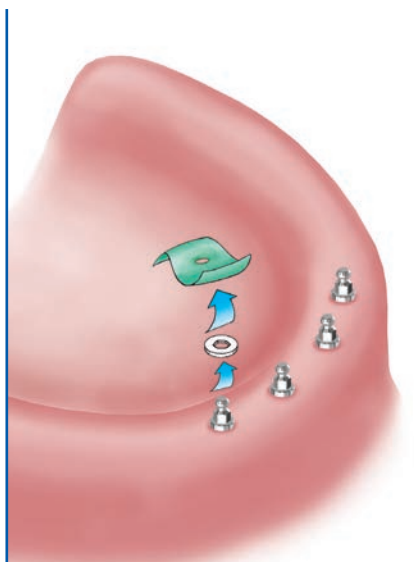

4.11 After the polymerization of the acrylic has been completed, the prosthesis is removed from the patient's mouth. The micro housings, due to their highly retentive surface, are kept in the prosthesis. Remove the rubber dams and the spacer rings from the monoimplants' heads.



4.12 Remove any acrylic excess until the edges of the micro housings are completely exposed. Correct any discrepancies that may interfere with proper seating of the appliance. Finish and polish the prosthesis.



### Prosthesis maintenance

Patients should be seen at least once every six months. Review should include assessment of prosthesis retention and replacement of damaged O-rings. In case of prosthesis relining, at the end of the procedure always replace the O-rings. If a simple prosthesis relining procedure is insufficient and it is necessary to reincorporate the metal housings into the prosthesis, remove the housings with a small bur and replace them with new housings following the above-mentioned procedure (points 4.6 - 4.12). Please remember that all the housings within the prosthesis should always be reincorporated together into the prosthesis and not only one or part of them.

### Replacing an O-ring

When replacing an O-ring, remove the old O-ring from the metal housing and lubricate the new O-ring with silicone spray or Vaseline to facilitate placement within the metal housing. Insert the new O-ring into the housing by using plastic forceps. Use a round-shaped instrument which can enter into the hole of the O-ring to push it into its seat with small circular movements. To improve visibility we recommend to work using a magnifier with a magnification of at least 4x.



## QUALITY FOR THE SATISFACTION OF THE CUSTOMER

The Leone quality system ensures and maintains the quality level of the products in accordance with the essential requisitions of 93/42 EEC Directive as amended, with the EU regulation 2017/745 or other mandatory provisions and in compliance with the expectations and the needs of the customer, and ensures that all processes and their interactions associated with the manufacturing of orthodontic and dental products, more specifically the research and development production processes, storage and distribution are established, implemented, maintained and improved in accordance with the requirements of the quality management system in conformity with the international standards ISO 9001, ISO 13485 under the regulation 93/42EEC in Annex II (Annex IX, Regulation EU 2017/745) and ISO 13485 in conformity with the requirements of the Countries participating at the program MDSAP (Medical Device Single Audit Program) such as SOR 98/282 Canada (also in accordance with CMDCAS requirements), USA-FDA 21 CFR Part 820, Japanese Ordinance MHLW n. 169, Therapeutic Good (Medical Devices) Australian Regulation 2002, Resolution RDC Anvisa n.16/2013 of Brasil and others dispositions and updates, and of others non-European Countries of final product's destination.

## CUSTOMER SERVICE

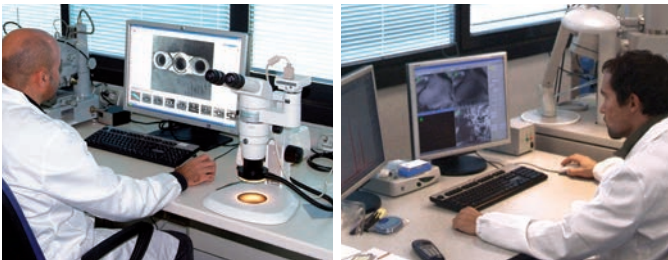

### COMPETENCE AND RELIABILITY

Our Service department is always on hand to provide information about products and solve any issues thanks to technicians and engineers who are under continuing professional update.



### PROMPTNESS OF DELIVERY

Careful management and an advanced logistics system allow the process of orders in a timely manner and deliver the goods to the carrier on average within 24 hours.

## LEONE NEWSLIST

Keep informed with the latest news of our products: click on "Services" in our website [www.leone.it](http://www.leone.it) and fill in the registration form.



### TECHNICAL AND COMMERCIAL ASSISTANCE

Contact your dealer in your country as a reference.  
You will find the comprehensive list under the section "Distributors" in our website  
[www.leone.it](http://www.leone.it)

## A

360° Anatomical abutments Standard and Large	46..48
Abutment Gauges	86
Abutment seater	87
All-on-Four surgical guide	16
Analogs	51

## B

Ball head abutments	80..82
Basic abutments Standard and Large	45
Bonding cylinders for MUA	69
Bone condenser tips	31
Bone grafting tips	31
Bone Profiler	25
Burn-out coping for Ti-Base for ExaConnect	62

## C

CAD-CAM interfaces for MUA	69
Conic adapter for MUA	74..76
Connecting rings	22
Connecting screw for ExaConnect	62
Connecting screws for MUA	71
Countersinks	20

## D

Demonstration Jumbo dental implant	90
Depth gauge	24-143
Depth stops	21
Digital analogs	53
Digital analogs for MUA	69
Drill extension	21
Drill stop kit	21

## E

ExaConnect	56..58
ExaConnect analog	60
ExaConnect Plus - sterile	56-57-59
Extension for instruments	23

## F

Fan-type wrench for monoimplant	144
Fixed caps	75-77

## G

Grommets	27
Guide pin	25

## H

Handle for abutments	89
Handpiece adapter	23
Handpiece adapter for monoimplants	144
Healing caps Standard and Large	34-35
Healing screw for ExaConnect	60
Healing screws for MUA	68
Hemi-mandible	90
Hex head extractor	24-88
Hexagons for 360° abutments	48
High burn-out cylinders for MUA	70
High Torque driver	22
Housing with medium insert orange	83
Housing with O-ring	84-142
Housing with rigid insert violet	83
Housing with soft insert white	83

## I

Implant card	90
Implants	10..15
Insert seating tool	84
Instrument for cover caps	24

## L

Lab and scan Ti-Base for ExaConnect	61
Lance drill	19



## M

Measuring pin for gingival height	24-143
Medium insert orange	83
Micro housing with micro O-ring	84-142
Micro O-ring	84-142
Mobile caps	75-77
Monoimplants for O-ring overdenture	140..144
MUA	64..67
MUA analogs	68
MUA Plus - sterile	64-65-67
Mucosa punch for contra-angle	25
Mucosa punch for contra-angle for monoimplants	143
Multifunctional screw for ExaConnect	62
Multifunctional screw for MUA	71
MultiTech abutments	49

## O

O-ring	84-142
Offset adapter for threaded handle	32
Organizer for Abutment Gauges	86
Organizer for implants and instruments	28-29
Organizer for monoimplants	143
Osteotomy instrument kit	30

## P

Paralleling pin	23
Patient information brochure	90
Pick-up transfer for ExaConnect	60
Pick-up transfer for MUA	68
Pilot drills	19
Positioner for Standard transfer	51
Prosthetic hand screwdriver	89
Prosthetic torque wrench	89

## R

Ratchet	23
Ratchet adapter	144
Removal tool for abutments	88
Repositionable transfer for ExaConnect	60
Repositionable transfer for MUA	68
Rigid insert violet	83
Round bur	19

## S

Scan Bodies Pyramid	52-61
Scan Body for MUA	69
Scan Body Inclined Plane	52-61
Scan Post	52
Scan Post positioner	53
Screw adapters	88
Seating tips	87
Sinus lift tips	31
Soft insert white	83
Standard burn-out cylinders for MUA	70
Surgical demonstration kit	90
Surgical guide	16
Surgical hand screwdriver	23
Surgical kits	26..27
Surgical mallet	32

## T

Taps for 6.5 Short implant	22
Taps for Classix implants	22
Template	16
Template for monoimplants	144
Temporary abutments for ExaConnect	62
Temporary abutments Standard and Large	44
Threaded handle	32
Ti-Base abutments	50
Ti-Base abutment for ExaConnect	61
Tip wrench	32
Titanium basin	24
Titanium wires for welding	70-77
Torque screwdriver 25 Ncm for laboratory	89
Transfers Standard and Large	51
Twist drills	19
Twist drills for hard bone	20

## W

Weingart style pliers	88
Welding caps	75-77
Welding cylinders for MUA	70

## X

XCN® 2.9 Narrow implants	14-15
XCN® 6.5 Short implant	14-15
XCN® Classix implants	10-11
XCN® Max Stability implants	12-13



# ISTITUTO STUDI ODONTOIATRICI

## EDUCATION, TRAINING, UPGRADE

Since 1982, ISO, Istituto Studi Odontoiatrici, has been operating with the purpose to promote new therapeutic techniques and to divulge dentistry and implant dentistry to ever higher standards. The Leone's teaching facility is spread out over two floors with a total surface area of 1.000 square meters. In over 37 years of activity, the ISO center has hosted more than 47.000 attendees.

ISO offers a comprehensive program of courses for dental surgeons, dentists, specialists in dentistry and orthodontics.

Hands-on courses for dental technicians and commercial training in orthodontics and implant dentistry for Italian and foreign traders are also available.



## STATE-OF-THE ART FACILITY

With the exception of the reception area, the first floor of the building is dedicated to the lecture rooms:

- a dental operatory equipped with 2 dental units for live demonstrations of both orthodontic and implantological interventions
- a lecture hall seating up to 40 participants, allows the doctors to visually participate in the interventions
- endoral and extraoral cameras film the procedures which are wired in to big screens in the various lecture halls at a real time
- a 18-bench dental laboratory fully equipped
- a multi-purpose lecture hall for 80 trainees has been recently endowed with the interactive learning Active Classroom environment, providing an interactive multi-media board and learners' active response tools which enable the attendees to become active participants in the courses.

On the second floor:



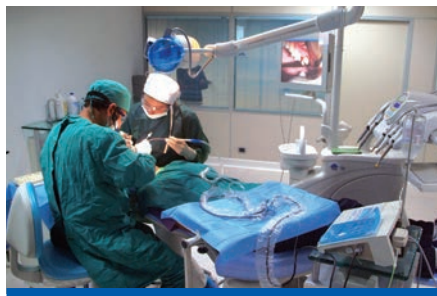

























- our "Marco Pozzi" lecture hall seating up to 250 participants. The didactic tools available at the ISO and the high qualified lecturers make each event a profitable and memorable one for every participant.









For detailed information on courses and events visit our website: [www.leone.it/english/iso](http://www.leone.it/english/iso)  
or contact the ISO reception office: Phone +39.055.304458 - Fax +39.055.304455 - [iso@leone.it](mailto:iso@leone.it)

Follow us  
on Facebook



PRODUCT LABEL SYMBOLS				
The label on the package of any medical device set on the market will show the symbols in compliance with the harmonized standards. The symbols marked with a single (*) are based on the ISO 21531, ISO 15223-1, the 93/42EEC Directive and Regulation (EU) 2017/745. The symbols marked with double (**) have been instead adapted by Leone.				
manufacturer's trade name and address		catalogue code		identification and description (in several languages) of a specific device with reference to the code number of the catalogue in use
CE mark (made in compliance with 93/42EEC Directive on class IIA or IIB medical devices)		expiry date, if the product is perishable (year/month/day)		storage temperature 
lot number * (indicated by LOT mark)		for professional use only		for single use only 
keep dry		this product contains Nickel-Chromium: possible allergic reactions		keep away from sunlight 
CE mark (made in compliance with 93/42EEC Directive on Class I medical devices)		read the documents enclosed		gamma-ray sterilized 
titanium		surgical steel		this product contains Chromium: possible allergic reactions 
autoclavable at temperature indicated		polyethylene		non-sterile 
do not use if package is damaged		polyetheretherketone		UDI Barcode / UDI Datamatrix Unique Device Identification "UDI" for the identification and the traceability of the medical device
read the instructions for use enclosed		with content or presence of natural rubber latex		
read the digital instructions for use available at the specified website		medical device		 (01) 08033707071846 (10) 19021101 (91) 196C000001 (240) 110-3308-02 (17) 260211 

\*Unless otherwise indicated, the LOT number explains the date of manufacture with the key YYMMDDNN (YY year, MM month, DD day, NN Leone progressive internal number of the lot).  
For example: 19021902 indicates the lot no. 2 of February 19, 2019.

SYMBOLY	Various symbols are used throughout this catalogue to highlight product specifications as follows:			
	height	H	connection colour coding 2.2 mm	 with integral hexagon 
	length	L	connection colour coding 3.0 mm	 without hexagon 
	diameter	∅	instrument with 1 notch	 with 360° hexagon 
	thread diameter	M	instrument with 2 notches	

### INFORMATION FOR DISTRIBUTORS OF DENTAL IMPLANTS: INTENDED USE, RESPONSIBILITY, SURVEILLANCE

The 93/42EEC Directive on medical devices is the official reference that dictates the regulations for marketing medical devices. The directive provides indications for all the phases of existence for the device (from the project phase through the traceability system, and surveillance), and it identifies all the characters who have to comply with the directive itself, which includes not only the manufactures, but also the distributors, the buyers, and even the users. As for the responsibilities of the single competence, Leone S.p.A. recommends to its direct clients, dental depots and exclusive dealers to follow and maintain the indications, warnings, and information for the univocal identification of the medical devices, as provided by the manufacturer on the labels, during all the marketing phases. With specific regard to Class IIB implantable products, all dental depots and exclusive dealers of Leone S.p.A. are required to keep records of the distribution of medical devices as of traceability available for verification, in case of need to trace back a product or its user in a univocal way.

Leone s.p.a. does not assume risk and liability resulting from the use of the products listed in this catalogue. Since they are intended for implanto-prosthetic use only, their use has to be restricted to skilled and licensed professionals, who will be held the sole responsible for the construction or the application of any implanto-prosthetic appliance partially or fully manufactured with the above mentioned products. All Leone products are designed and manufactured for single use and once removed from the patient's mouth, must be disposed of properly. Leone s.p.a. disclaims any liability for the spread of disease or personal injury caused by reuse.



## HOW TO REACH LEONE

### BY AIRPLANE

from the Peretola airport "A. Vespucci", five minutes by taxi.

### BY CAR

- from the highway "Autostrada del Sole", exit Firenze Aeroporto, in the direction of Florence.
- Along the highway A11, exit Sesto Fiorentino, on your right side the Novotel and Ibis Hotel can be seen.
- At the second traffic circle, turn on the first exit on the right (McDonald's).

GPS coordinates: +43° 48' 4.85" N, +11° 11' 0.23" E

### BY TRAIN

from the central station "Santa Maria Novella", take bus no. 30, get off in Via Pratese near the car dealer Volkswagen.

Call **+39 055.3044620**

or send an e-mail message to [export@leone.it](mailto:export@leone.it) for further information on Leone products or a visit to our factory.

You can also visit our website: [www.leone.it](http://www.leone.it)

All rights reserved. No part of this catalogue may be reproduced in any form.

Due to continuing product improvements, Leone s.p.a. reserves the right to discontinue products or change the design and materials of products without notice.

Layout and realization by: Graphic department of Leone S.p.a

Printed by: ABC TIPOGRAFIA s.r.l. Calenzano, Firenze

La copertina di questo catalogo è stampata su carta ecologica realizzata con sottoprodotti di lavorazioni agro-industriali (residui di uva, agrumi, kiwi, mais, caffè, olive, lavanda, ciliegie, nocciole e mandorle) che sostituiscono fino al 15% della cellulosa proveniente da albero. OGM free, contiene 40% di riciclato post consumo ed è realizzata con EKOenergia. Carbon footprint ridotta del 20% utilizzando scarti agro-industriali e 100% energia verde. È protetta da brevetto europeo sia di prodotto che di processo produttivo.

The cover of this catalogue is printed on ecological range of papers made using process residues from organic products (citrus fruits, corn, olives, coffee, kiwi fruits, hazelnuts and almonds) to replace up to 15% of virgin tree pulp. GMO free, contains 40% post-consumer recycled waste and is produced with EKOenergy. The carbon footprint is reduced by 20% using by-products and 100% green energy. This paper and the production process are patented.

